

International Business Machines Corporation

Information Products Division

Form No. S544-4108-0

Printed in USA

P/N 1432624

4/88

PROPERTY OF FIELD AND PRODUCT SUPPORT
NOT TO BE REMOVED FROM OFFICE OR
SUPPORT CENTER. THANK YOU.

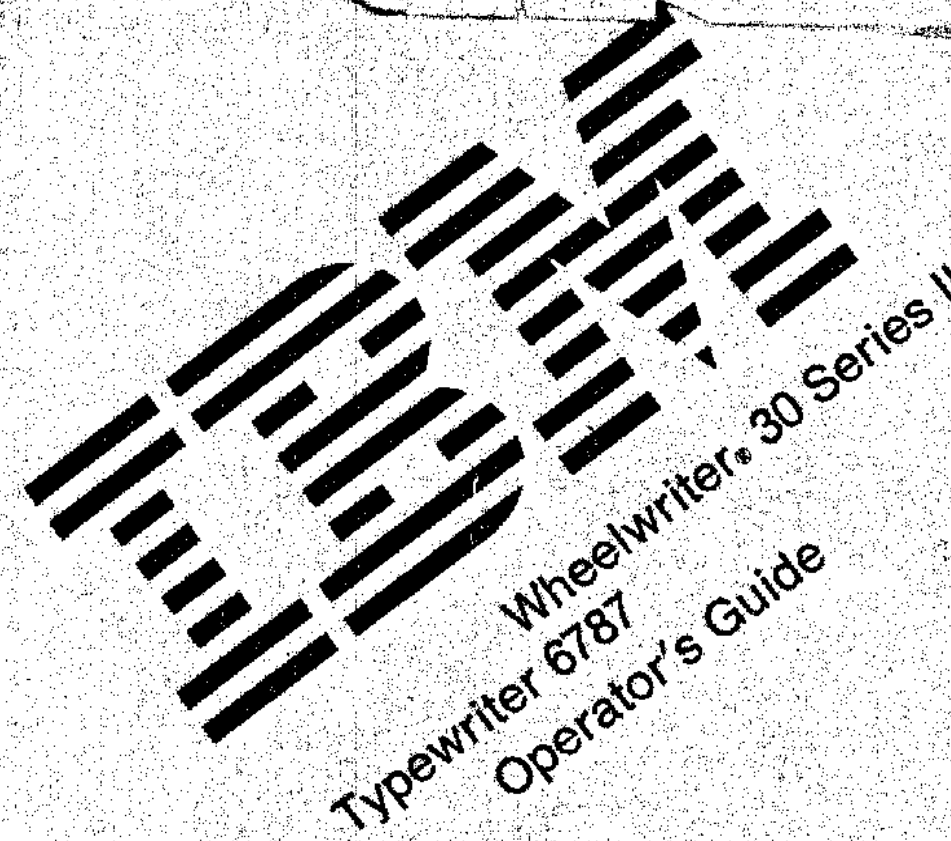

S544-4108-00

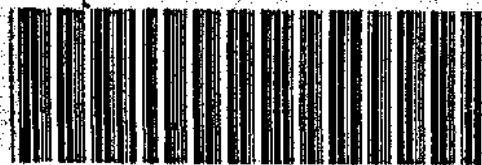

First Edition (March 1988)

The following paragraph does not apply to the United Kingdom or any country where such provisions are inconsistent with local law: INTERNATIONAL BUSINESS MACHINES CORPORATION PROVIDES THIS PUBLICATION "AS IS" WITHOUT WARRANTY OF ANY KIND, EITHER EXPRESS OR IMPLIED, INCLUDING, BUT NOT LIMITED TO, THE IMPLIED WARRANTIES OF MERCHANTABILITY OR FITNESS FOR A PARTICULAR PURPOSE. Some states do not allow disclaimer of express or implied warranties in certain transactions; therefore, this statement may not apply to you.

This publication could include technical inaccuracies or typographical errors. Changes are periodically made to the information herein; these changes will be incorporated in later editions of the publication. IBM may make improvements and/or changes in the product(s) described in this publication at any time.

Publications are not stocked at the address below. For copies, contact your IBM Authorized Dealer.

You can send comments or suggestions using the form in the back of this book. If the form has been removed, simply address your comments to the IBM Corporation, Dept. F98/962-3, 740 New Circle Road N.W., Lexington, KY 40511, USA. Information you supply may be used by IBM without obligation. You may, of course, use it yourself. Necessary changes will be made in later editions of the manual.

References to IBM products, programs, or services do not imply that IBM intends to make them available outside the United States.

© Copyright International Business Machines Corporation 1988. All Rights Reserved.

FCC Notice

The IBM Wheelwriter® 30 Series II Typewriter 6787 generates and uses radio frequency energy. If the typewriter is not installed and used in accordance with the installation instructions, operating instructions, and service manual, it may interfere with radio or television reception. This typewriter has been tested and found to comply with the limits for a Class B computing device pursuant to Subpart J of Part 15 of FCC rules, which are designed to provide reasonable protection against such interference when operated in a residential area.

If this typewriter interferes with radio or television reception, which can be determined by switching the typewriter off and on, the user is encouraged to try one or more of the following:

- **Move the receiving antenna on the radio or television.**
- **Relocate the typewriter in relation to the radio or television.**
- **Plug the typewriter into a different electrical outlet from the radio or television.**

If necessary, consult your IBM Authorized Dealer. If anyone other than an IBM Authorized Dealer modifies the typewriter and it causes interference, the user is responsible for correcting the interference.

Safety Information

This machine has additional insulation that provides extra protection against the risk of electric shock and does not rely on grounding. This machine has a nongrounding-type (2-wire) power cord because grounding is not necessary.

For continued protection against the risk of electric shock and personal injury:

- Connect the machine only to an outlet of the correct voltage. The voltage your machine will accept is indicated on the machine.
- Make sure the machine is turned off (O) before you connect or disconnect the power cord or interconnecting cables.
- Do not use the machine in an area where it can become wet.
- Keep hair and personal articles away from moving parts in the machine to avoid the possibility of getting them caught.
- Refer service or repair to qualified service personnel.
- There may be some increased risks of electric shock and personal injury during disassembly and servicing of this machine. Professional service personnel should understand this and take necessary precautions.
- The safety features of some parts may not always be obvious. Therefore, replacement parts must have the identical or equivalent characteristics as the original parts.
- The maintenance information for this machine has been written for the professional service person and is not intended to be used by others.

About Your Typewriter

Congratulations! You are about to experience typing with your new *IBM Wheelwriter® Series II Typewriter*.

This typewriter was designed with you in mind. Several new functions have been added that will give you excellent typing quality and make the tasks you have to perform more enjoyable.

This typewriter has an adjustable, one-line display that you can tilt to a comfortable viewing angle.

The paper and cursor/carrier movement keys, located to the right of your keyboard, allow you to move quickly and easily to any location on the paper and the display—up, down, left, or right.

Special functions such as Automatic Centering, Word Underlining, Word Erase, Justification, Bold Print, and Spell Check II are all designed to make your typing jobs easier, faster, and more productive.

The Storage function allows you to store jobs that you may want to use later. The typewriter has a storage capacity of approximately 30,000 bytes (approximately 10 to 15 pages). After you store a job, you can play it back and revise it without retyping the entire job. In addition, you no longer have to retype frequently used jobs; for example, form letters, repetitive paragraphs, and statistical reports.

Just tell your IBM typewriter what you want it to do!

You can enhance the use of your *IBM Wheelwriter® Series II Typewriter* by adding the following options:

- Diskette Option
- Memory Expansion
- Pinwheel Form Feeder
- Printer Option

About this Manual

The purpose of this manual is to aid you in performing your work efficiently through the use of your new typewriter. You should know how to type and have used basic typewriter functions prior to using this manual.

The manual is divided into the following chapters:

- **Basic Operations** explains and illustrates the parts of this typewriter. It is designed to familiarize you quickly with the hardware and how it operates. It provides instructions to use the basic functions and the standard keys on a typewriter.
- **Advanced Operations** helps you to use advanced functions of the typewriter such as underlining, centering, special characters, indenting, and decimal tabulation.
- **Basic Storage** explains how to store text, recall it, revise it, and play back a copy.
- **Menu Functions** enables you to use several special functions of your typewriter.
- **Advanced Storage** describes the special storage functions of your typewriter.
- **Alternate Keyboards** explains how to type in another language and use special applications keyboards.
- **Reference** describes your typewriter supplies, ordering and installation procedures, and application recommendations.
- **Problem Determination** helps in answering questions you may have while using your typewriter.

The Appendixes describe Spell Check II and the Diskette Option.

Contents

Basic Operations	1-1
Parts of the Typewriter	1-1
Keyboard Layout	1-2
On/Off Switch	1-3
Display Adjustments	1-4
Display Symbols	1-6
Display Indicators	1-7
Code Key	1-8
Line Space Key	1-9
Typematic (Repeat) Keys	1-9
Keyboard Height Adjust Levers	1-10
Page End Indicator and Scale	1-11
Keyboard Clicker	1-11
Inserting Paper	1-12
Paper, Carrier and Cursor Movement Keys	1-13
Removing Paper	1-14
Impression Control	1-15
Cardholder	1-16
Shift and Lock Keys	1-17
Caps Key	1-17
Printwheel Identification	1-18
Choosing a Printwheel	1-18
Automatic Pitch Selection	1-19
Margin/Pitch Scale	1-20
Margins	1-21
Tabs	1-22
Margin and Tab Formats	1-23
Correction Memory	1-26
Erasing Automatically in 10, 12, and 15 Pitch	1-27
Relocate Key	1-28
Erasing Manually in 10, 12, and 15 Pitch	1-29
Erasing in Proportional Spacing (PS)	1-30
Inserting an Extra Character	1-32
Advanced Operations	2-1
Automatic Carrier Return	2-1
Required Space and Required Hyphen	2-3
Underlining	2-4
Centering	2-5

Right Flush	2-7
Subscripts and Superscripts	2-9
Special Characters	2-11
Bold Print	2-11
Indenting	2-12
Decimal Tabulation	2-14
Choosing a Print Mode	2-17
Justification	2-18
Changing Printwheels While Typing	2-20
Changing the Top Margin	2-22
Basic Storage	3-1
Storage Overview	3-1
Storing a Job	3-2
Playback Overview	3-4
Playing Back a Stored Job	3-4
Margin and Tab Formats in Stored Jobs	3-8
Typing Hyphens in a Stored Job	3-11
Revision Overview	3-14
Revising a Stored Job Using Character or Delay Print	3-15
Correcting Errors with Storage Closed	3-20
Revising a Stored Job Using No Print	3-21
Storage Rules	3-25
Playback Rules	3-26
Revision Rules	3-27
Deleting Stored Jobs	3-28
Deleting All Storage Areas	3-28
Using Stop Codes in Storage	3-29
Stop Code Applications	3-30
Menu Functions	4-1
Identifying the Current Storage Area	4-1
Using the Menu Key	4-2
Directory	4-3
List	4-6
Storage Full	4-8
Page-Format	4-9
Page-Layout	4-10
Page-Layout Settings for Pinwheel Form Feeder	4-12
Auto Page End	4-13
Tab Adjust	4-15
Advanced Storage	5-1

Justification during Playback	5-1
Hyphenation during Playback	5-3
Using Find	5-7
Using Change	5-12
Form Letters	5-16
Document Assembly	5-18
Using Mark for Preprinted Forms	5-24
Required Page Ends	5-29
Alternate Keyboards	6-1
Using Alternate Keyboards	6-2
Keyboard Alphabetic Cross-Reference	6-3
Keyboard Charts	6-4
Reference	7-1
Ordering Procedures for IBM Supplies	7-1
Typestyle Samples	7-1
Printwheel Application Recommendations	7-4
Removing the Printwheel	7-6
Installing the Printwheel	7-7
Ribbon Cassette System	7-8
Removing the Cassettes	7-8
Installing the Cassettes	7-9
Ribbon Application Recommendations	7-10
Ribbon Cassette Reorder Numbers	7-11
Batteries	7-12
Care and Maintenance	7-16
Serial Number	7-16
Problem Determination	8-1
How to Use This Chapter	8-1
Problem Determination Index	8-2
Typewriter Problems	8-3
Messages and Error Codes with Beep Signals	8-8
Messages and Indicators without Beep Signals	8-10
Display Symbols	8-15
Display Indicators	8-16
Typewriter Messages	8-17
Spelling Function Messages	8-18
Diskette Option Messages	8-18
Appendix A. Spell Check II	A-1
Using Spell Check II	A-3

Supplemental Dictionary	A-4
Checking All Words In a Job	A-6
Spell Assist	A-7
Changing the Sound of the Spelling Beep	A-8
Appendix B. Diskette Option	B-1
Using the Diskette Option	B-1
Setup Procedures	B-3
Placement of the Diskette Drive	B-4
Using and Handling Diskettes	B-5
Write-Protecting Diskettes	B-6
Inserting a Diskette	B-7
Removing a Diskette	B-7
Preparing a Diskette	B-8
Diskette Storage	B-10
Storing a Job on a Diskette	B-12
Playing Back a Job Stored on a Diskette	B-12
Identifying the Current Diskette Storage Area	B-12
Revising a Job Stored on a Diskette	B-13
Deleting a Job Stored on a Diskette	B-13
Quit Revision without Storing	B-14
Using More than One Diskette	B-14
Diskette Directory and List	B-15
Changing or Checking the Title of the Diskette	B-17
Copying Jobs	B-18
Copying from One Diskette to Another Diskette	B-19
Index	X-1

Basic Operations

Parts of the Typewriter

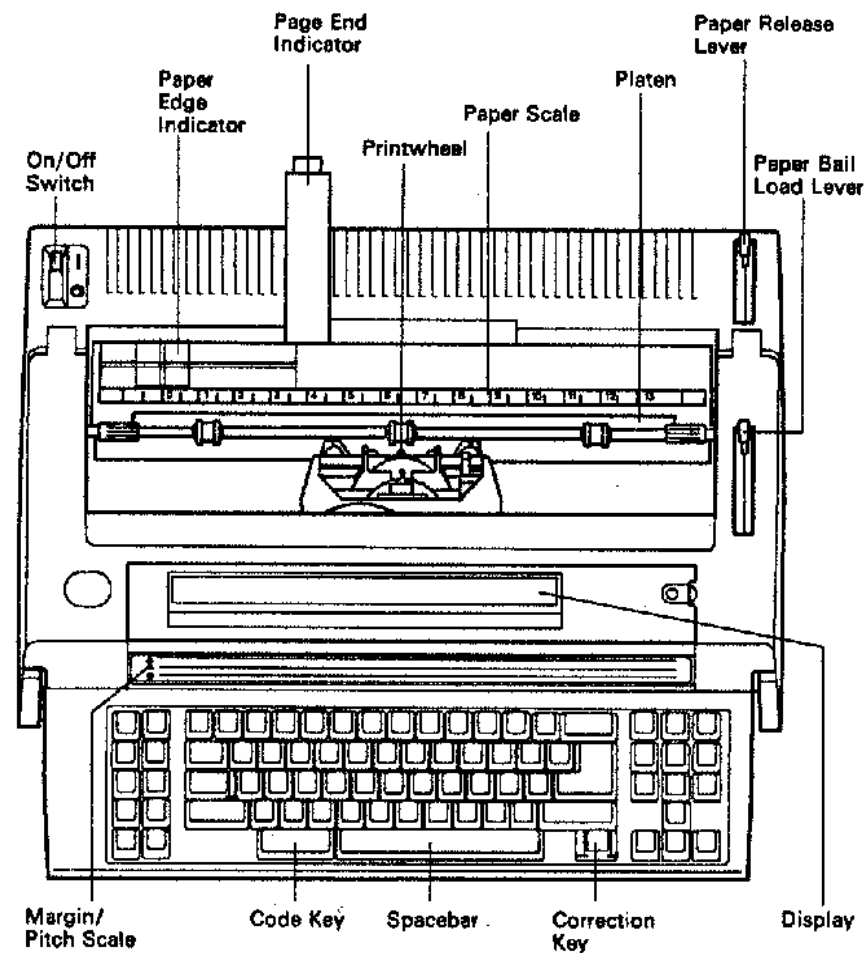

Keyboard Layout

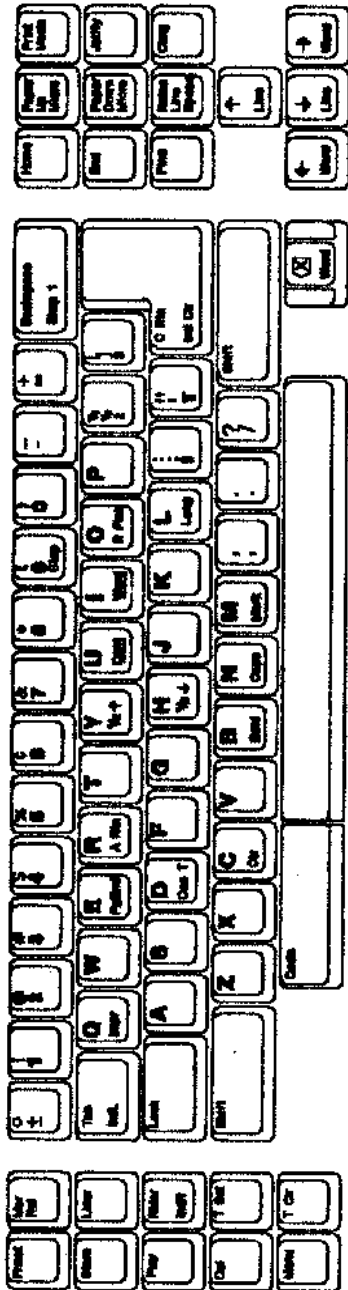

On/Off Switch

Push the on/off switch toward the back of the typewriter (next to the ) to turn the typewriter on.

- When you turn the typewriter on for the first time, the **STORAGE CLEARED** message and the **SPELL** indicator are displayed. The **STORAGE CLEARED** message goes off when you begin typing. The **SPELL** indicator signals that the Spelling function is turned on. See "Appendix A. Spell Check II" on page A-1 for more information.



- Each time you turn the typewriter on, wait approximately five seconds for the typewriter to beep and the line space symbol to be displayed before you begin typing.
- If you turn the typewriter on and the following appears on the display, see "Checking the Batteries" on page 7-13.

Line Space Symbol



Pull the on/off switch toward you (next to the ) to turn the typewriter off.

Helpful Hints

- A printwheel must be installed before you can type. If not, the **WHEEL** indicator is displayed. For more information, see "Installing the Printwheel" on page 7-7.
- Do not turn the typewriter off while it is busy. The typewriter is busy when the **BUSY** indicator is displayed.
- Wait at least five seconds after turning the typewriter off before you turn it back on. This allows the typewriter to reset.

Display Adjustments

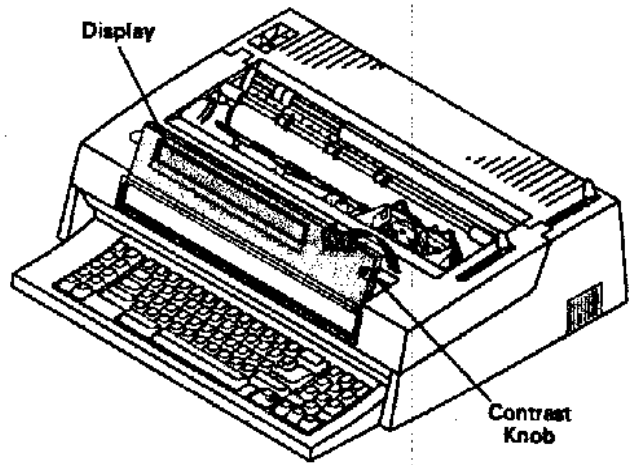

1. Pull the display forward to raise it.
2. To reduce glare, tilt the display to a comfortable viewing angle.
3. To adjust the contrast, rotate the contrast knob on the right side of the display until the characters are clearly readable.
 - The display temperature and room light can affect how characters appear on the display.

Display

The *display* shows what you are typing. As you type, occasionally look at the display for messages or indicators or to check your typing.

The display shows 71 characters at a time. If you type more than 71 characters, the text line on the display clears and shows the last five characters you typed, then shows each additional character as you type it.

Messages are displayed to help you use the typewriter functions and inform you of typewriter conditions. For example, the STORAGE CLEARED message is displayed the *first time* you turn the typewriter on to let you know that typewriter storage is empty. The symbol and number 1 on the right end of the display let you know the current line space setting (single spacing, for example).

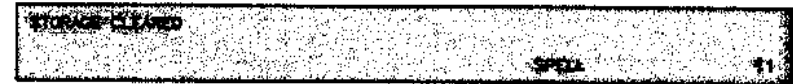

The *cursor* is the pair of horizontal blinking lines on the display. The cursor is displayed at the current typing position.



An *indicator* is a word or abbreviation that shows you which typewriter function is active. For example, SHIFT indicates that all characters will print in uppercase. The SPELL indicator is displayed if the Spelling function is turned on. See "Appendix A. Spell Check II" for more information.



Display Symbols

The following symbols may appear during normal operation of the typewriter.

Symbol	Meaning
	Bold. This symbol is displayed above each character typed using Bold.
	Centering. This symbol is displayed at the beginning and end of centered text.
	Decimal Tab (Begin). This symbol shows where the decimal tab text begins.
	Decimal Tab (End). This symbol shows where the decimal tab text ends.
	Indent Clear. This symbol is displayed when you hold down Code while you press CRtn to end indenting. The symbol is displayed <i>only</i> when revising a stored job.
	Indent Left. This symbol is displayed when you hold down Code while you press Tab to set a temporary left margin.
	Indent Right. This symbol is displayed when you hold down Code while you press RMar to set a temporary right margin.
	Line Space. This symbol is displayed next to the current line space setting (1, 1 1/2, 2, or 3).
	Mark. These symbols are displayed when you hold down both Code and Shift while you press M to mark a form layout. These symbols are displayed <i>only</i> when revising a stored job.
	Pitch Change. This symbol is displayed when you resume typing after changing pitch.
	Required Carrier Return. This symbol shows a carrier return that always plays back. For example, if you press CRtn before the right margin, the carrier return is required. The typewriter always plays back that carrier return at that point in the job. If several symbols are displayed together and/or a symbol is displayed at the beginning of a line, one blank line will play back for each symbol.
	Required Page End. This symbol is displayed when you hold down Code while you press E to end a page of a multipage job. This symbol is displayed <i>only</i> when revising a stored job.
	Right Flush. This symbol shows you where right flush text begins and ends.

Symbol	Meaning
	Subscript. This symbol is displayed when you hold down Code while you press H to type a subscript.
	Superscript. This symbol is displayed when you hold down Code while you press Y to type a superscript.
	Stop Code. This symbol is displayed before and after a stop code comment. If you did not type a stop code comment, two symbols appear to show the position of the stop code.
	Stop Code. During playback, these symbols are displayed when playback stops for a stop code and you have not typed a stop code comment. If you typed a stop code comment, it is displayed between the symbols.
	Tab. This symbol is displayed when you press Tab.

Display Indicators

Display	Description	Page
ARTN	Automatic Carrier Return on	2-1
APAGE	Auto Page End on	4-13
BOLD	Bold Print on	2-11
BUSY	Typewriter Busy	1-3, 8-10
CAPS	Caps on	1-17
CENTER	Centering on	2-5
CONT	Continuous Underline on	2-4
DEC T	Decimal Tab on	2-14
DL PRT	Delay Print Mode on	2-17
HYPHEN	Hyphenation on	2-1, 5-4
IMPR n	Impression Level (1, 2, or 3)	1-15
JSTIFY	Justification on	2-18
1, 1 1/2, 2, 3	Line Spacing	1-9
KYBD nnn	Keyboard (number)	8-2
LO-BAT	Low Battery	8-8
NO PRT	No Print Mode on	2-17
PLAY	Play	3-5
RFLUSH	Right Flush on	2-7
SHIFT	Shift	1-17
SPELL	Spell Verification on	A-3
STORE	Storage open	3-2
SUSPND	Suspended Playback	5-20
T ADJ	Tab Adjust on	4-17
WHEEL nn	Install Printwheel (number)	2-21, 3-28

Code Key

The **Code** key is used with other function keys. The **Code** key and the keys with green lettering can be used to print special characters and turn functions on and off. The **Spacebar**, **Paper Ball Load Lever**, **Hyphen (-)**, and **8** can also be used with the **Code** key.

When you use two keys at a time, hold down **Code** (the first key) while you press the function key.



The keys that are used in combination with the **Code** key are shaded in the keyboard chart below.

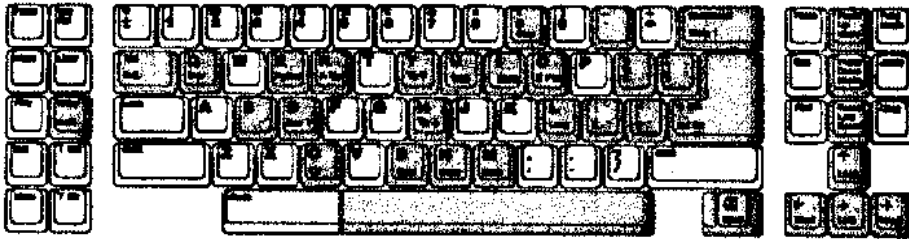

Important: If you accidentally access a function, repeat the action to turn the function off. If you are unsure of which keys you pressed:

1. Check the display for an indicator.
2. Find the indicator on page 1-7.
3. Turn to the page listed and follow the instructions for turning the function off.

Other messages and menus can be cleared by pressing the **Correction** key.

Line Space Key

When you turn the typewriter on, a line space symbol and a number are shown on the right side of the display. You can change the line spacing to 1, 1½, 2, or 3 (single, one-and-a-half, double, or triple spacing).



Hold down **Code** while you press **Reloc (Line Space)** until the desired line spacing is displayed.

- The number displayed next to the line space symbol changes to indicate the spacing selected.
- The line space setting is saved when the machine is turned off.

Typematic (Repeat) Keys

Typematic keys have both a single and repeat action. Press the desired typematic key lightly for a single action or hold down for more than one-half second for repeat action.

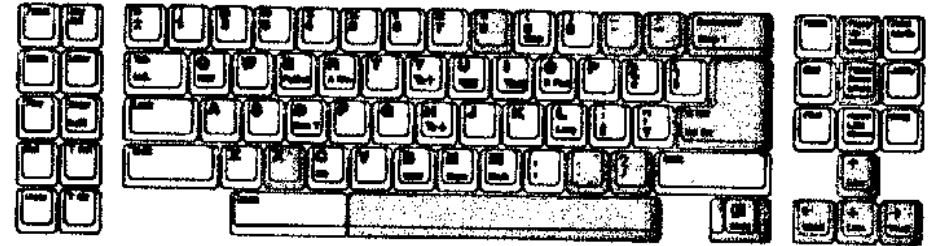

Keyboard Height Adjust Levers

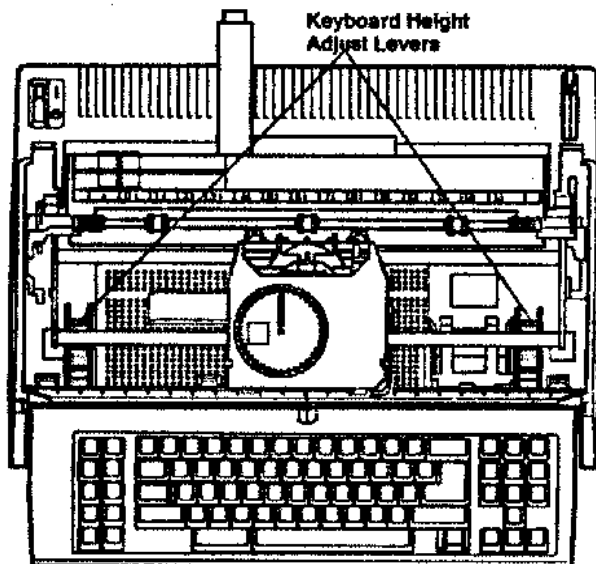

The keyboard can be raised or lowered to the most comfortable position by using the keyboard height adjust levers. There are three positions: low, medium, and high.

1. Use the **Spacebar** to move the carrier to the center of the typewriter.
2. Turn the typewriter off.
3. Raise the top cover.
4. Locate the two blue keyboard height adjust levers. They are located on the inside of the typewriter on the right and left sides of the bottom panel.
5. Push down on the levers and slide them to the desired position until they lock into place.
 - When the levers are all the way forward, the keyboard is in the *high* position.
 - When the levers are in the middle, the keyboard is in the *medium* position.
 - When the levers are all the way back, the keyboard is in the *low* position.
6. Make sure both levers are locked into the same position.

Page End Indicator and Scale

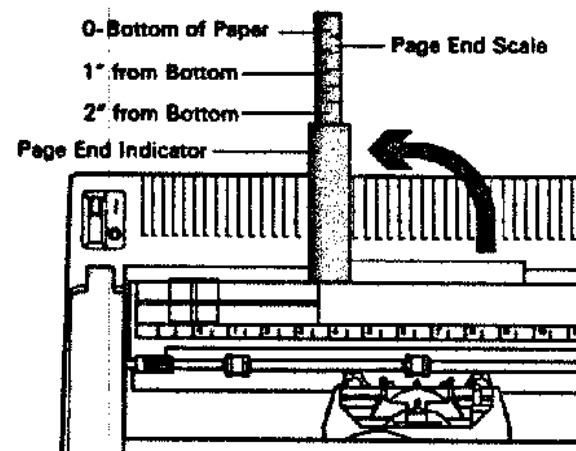

1. Raise the page end indicator until it is straight up.
2. Pull the page end scale all the way out until it locks into place.
 - As you type, the top of the paper comes out of the typewriter and moves up to the lines on the scale.
 - The lines on the scale tell you approximately how much space remains to the bottom of 27.9 cm (11 in) paper.
 - The left side of the scale is marked in inches. The right side is marked in centimeters.

Keyboard Clicker

The keyboard has a clicker that you can turn on or off. Your typewriter is shipped with the clicker off. You can turn the clicker on if you want more keyboard feedback while typing. You will hear the click each time you press a key.

- Hold down **Code** while you press **S** to turn the clicker on or off.

Inserting Paper

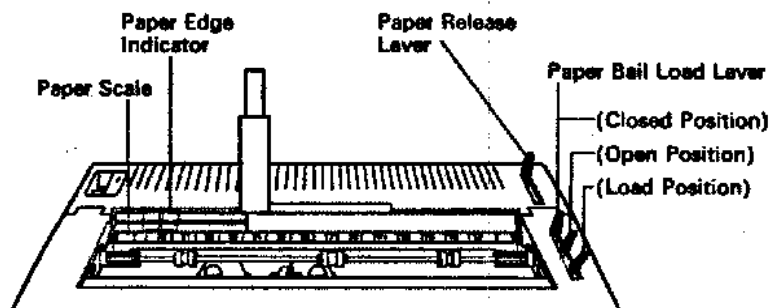

The typewriter has a paper ball load lever to assist you in loading paper semiautomatically. The lever has three positions: closed, open, and load.

1. Make sure the typewriter is turned on.
2. Push the paper release lever all the way to the back of the typewriter.
3. Align the center of the paper edge indicator with the vertical line to the left of zero (0) on the paper scale.
4. Align the left edge of the paper with the vertical line in the center of the paper edge indicator.
5. Pull the Paper Ball Load Lever all the way forward to the load position. When the paper begins to feed, let go of the Paper Ball Load Lever.
 - The paper feeds to the top margin position.
6. Push the Paper Ball Load Lever all the way back until it holds the paper against the platen.

You can change the top margin from one inch to a different top margin setting. This new setting is saved until you change it. You will learn how to use the Paper Ball Load Lever to do this in "Changing the Top Margin" on page 2-22.

Note: When inserting loose carbon copies (five maximum), pull the paper release lever forward. Insert the copies, then push the lever all the way back.

Paper, Carrier and Cursor Movement Keys

The paper, carrier and cursor movement keys allow you to move rapidly from one point to another. You now have the advantage of express movement both right and left as well as top to bottom on a page of text.

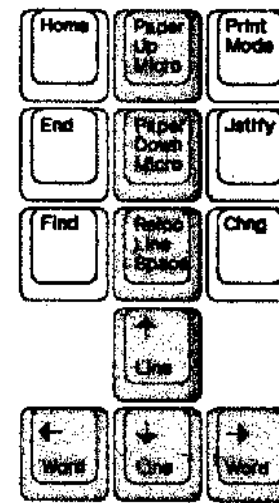

Moving the Paper

Use the following keys to move the paper in your typewriter: Paper Up, Paper Down, ↑, or ↓.

- Press Paper Up or Paper Down once to move the paper up or down one-half line.
- Hold down Code while you press Paper Up or Paper Down to move the paper up or down one micro-index (1/48") for precise alignment.
- Press ↑ or ↓ to move the paper down or up the number of lines determined by the line space setting.
- Hold down Code while you press ↑ or ↓ when you want to skip blank lines on a typed page and move directly to lines of text.

Note: Holding down ↑ or ↓ provides an express action to move quickly from line to line on a page.

Moving the Carrier and Cursor

Carrier is used below to denote the use of cursor and carrier. Use the following keys to move the carrier:

- Press ← to move the carrier backward on the current typing line.
- Hold down **Code** while you press ← (**Word**) to move the carrier backward to the previous word.
- Press → to move the carrier forward on the current typing line.
- Hold down **Code** while you press → (**Word**) to move the carrier forward to the next word.
- After you have moved the carrier, press **Reloc** (Relocate) to return the carrier to the last typing position.

Note: Holding down ← or → provides an express action to move quickly from point to point on a line.

Removing Paper

1. Pull the **Paper Ball Load Lever** toward you to the open position. (See the illustration on page 1-12).
2. Pull the *paper release lever* toward you, then lift the paper out of the typewriter.
3. Push the *paper release lever* and **Paper Ball Load Lever** all the way back to the closed position.

Note: Use the paper release lever instead of the ↓ key to remove paper.

Impression Control

The impression control can be set for three positions: light (1), normal (2), and heavy (3). When the typewriter is turned on, the Impression control is automatically set to 2 (normal). You can change the setting to suit your typing needs. For example, you may want to type with the Impression set to 1 to achieve the highest quality corrections with the **Correction** key, or you may want to change the impression to 3 when typing several carbon copies.

- Hold down **Code** while you keep pressing **Q** (**Impr**) until the desired setting is selected, then release the keys.
 - The **IMPR** indicator is displayed followed by the Impression control setting (1, 2, or 3). The **IMPR** Indicator is displayed as long as **Code** is held down.

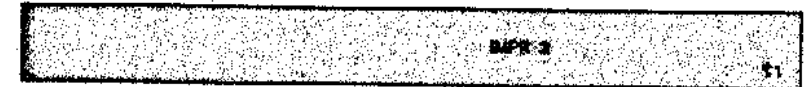

Cardholder

The cardholder holds paper, cards, and envelopes against the platen.

The printwheel pointer shows the position where the next character will print.

The top red portion (A) of the cardholder indicates the base of the typing line. As the typewriter prints, the bottom of each character rests just above the line, as shown below.

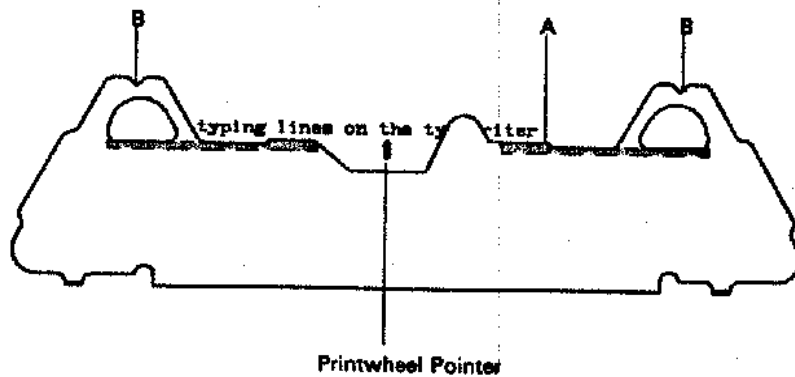

You may use the notches (B) to draw vertical lines.

- Hold a pencil or pen against one of the notches while pressing **Paper Up**, **Paper Down**, **↑**, or **↓** to move the paper.

Shift and Lock Keys

Use the **Shift** and **Lock** keys to type uppercase characters. The **Lock** key allows you to type continuously in uppercase (all capitals) without pressing **Shift** for each capital letter.

1. Press **Lock** to type in uppercase.
 - The **SHIFT** indicator comes on.
2. Press either **Shift** key to return to normal typing.
 - The **SHIFT** indicator goes off.

Note: Turning the Caps function on cancels **Lock** and displays the **CAPS** indicator. See "Caps Key" below.

Caps Key

If you need to type numbers and capital letters together, use the **Caps** function.

Caps is similar to **Lock**. When the **Caps** function is on, *only* the alphabetic letters (a through z) are capitalized. Numbers and punctuation marks print in lowercase. The **Caps** function eliminates shifting back and forth between uppercase and lowercase.

Example

THE CAPS FUNCTION LETS YOU TYPE NUMBERS MIXED WITH UPPERCASE LETTERS, AS IN JULY 6, 1988, PHONE 123-4567, OR EMPLOYEE NUMBER 543210.

Hold down **Code** while you press **N (Caps)** to turn **Caps** on or off.

- The **CAPS** indicator is displayed when **Caps** is on.

Note: Turning the **Lock** function on cancels **Caps** and displays the **SHIFT** indicator. See "Shift and Lock Keys" above. You cannot turn **Caps** off by pressing **Shift**.

Printwheel Identification

Your typewriter uses an IBM Cartridge Printwheel II. Printwheels are available in many different typesizes and pitches. See "Typestyle Samples and Pitches" on page 7-2 for a list of typestyles. You can choose from four different pitches as shown in the chart on page 1-19.

The illustration below shows where to find the typesize, pitch, and reorder number on the printwheel.

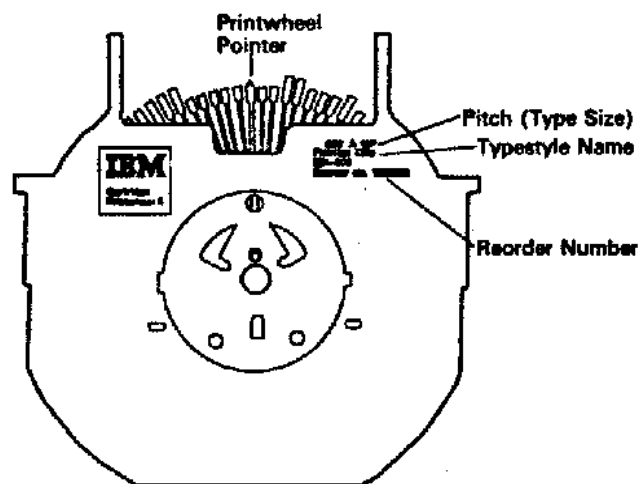

Choosing a Printwheel

A 10- or 12-pitch printwheel is recommended for use while you are learning to use your typewriter. All examples or practices in this manual are illustrated in 12-pitch type.

If you need to install or change your printwheel, refer to pages 7-6 and 7-7.

Automatic Pitch Selection

The correct pitch is automatically selected by the typewriter when you install a printwheel. The pitch determines the number of characters typed per horizontal inch.

The following table summarizes printwheel pitches with print examples of each pitch.

Pitch (Type Size)	Characters Per Inch	Pitch Symbol	Print Example
10P (Pica)	10	▲	This is a sample.
12P (Elite)	12	△	This is a sample.
PS (Proportional Spacing)	Varies in Width	●	This is a sample.
15P (Micro Elite)	15	■	This is a sample.

Lines Per Vertical Inch

- A printwheel for 10, 12, or PS pitch prints six lines per vertical inch.
- A printwheel for 15 pitch prints eight lines per vertical inch.

Margin/Pitch Scale

The typewriter has three margin scales: 10 ▲, 12 △, and 15 ■. When typing, use the scale line that matches the pitch symbol on your printwheel.

- For 10 ▲ pitch (pica) type, use the upper scale.
- For 12 △ and PS ● pitch (elite and proportional spacing) type, use the middle scale.
- For 15 ■ pitch (micro elite) type, use the lower scale.

An orange pointer moves along the scale on your typewriter to show the position of the next character to print.

The margin/pitch scale also contains centering marks. When the left paper edge lines up with zero on the margin/pitch scale:

- marks the approximate center of paper 215.90 mm (8.50 in) wide.
- marks the approximate center of paper 210 mm (8.27 in) wide.

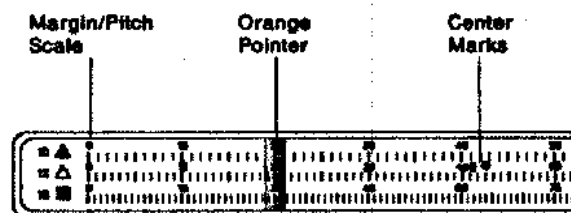

Margins

1. Press **Spacebar**, **Backspace**, **←**, or **→** to move the carrier to the desired position, then press **LMar** to set the left margin.
 - The old margin is automatically eliminated when a new margin is set.
2. Move the carrier to the desired position, then press **RMar** to set the right margin.
 - The old margin is automatically eliminated when a new margin is set.

Margin Release Key

1. Return the carrier to the left margin.
2. Press **MarRel** to release the left margin.
3. Press **Backspace** or **←** to move to the left of the margin.

Helpful Hints

- The carrier does not lock at the right margin. This allows you to type or space through the right margin. If the ARTN indicator is *not* displayed, or both the ARTN indicator *and* the HYPHEN indicator are displayed, the typewriter will beep approximately five spaces before the right margin setting. See page 2-1 for more information.
- Margins are saved when your typewriter is turned off.

Tabs

Setting a Tab

1. Press **Spacebar**, **Backspace**, **←**, or **→** to move the carrier to the desired tab position.
2. Press **TSet** to set a tab.

Clearing a Tab

1. Press **Tab** to move to the tab stop you want to clear.
2. Press **TClr** to clear the tab.

Clearing All Tabs

1. Hold down **TClr** while you press **CRtn**.
2. Release the keys.
 - The carrier does not move when you release the keys.
 - The carrier can be at any position when you clear all tabs.

Helpful Hints

- Permanent tabs exist at the left and right margins. These tabs cannot be cleared.
- You can set up to 26 tab positions at a time. The display will show up to 15 tab positions at one time.
- Tabs are saved when your typewriter is turned off.

Margin and Tab Formats

Use the **Fmat** key to display margins, tabs, format area, and current carrier position. The term *format* means a set of margins and tabs. For example, one format might be: left margin 20; right margin 80; tabs 30 and 40. There are nine format areas (1 through 9) to save margins and tabs.

Displaying Formats

Hold down the **Fmat** key.

- The current carrier position, margins, tabs, and format area are displayed as long as you hold down the **Fmat** key. Information similar to the following is displayed when margins and tabs are set:

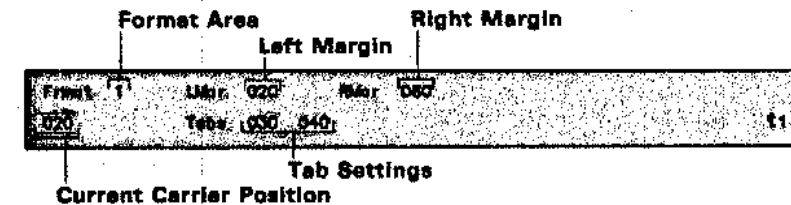

This display example indicates that you are using format area 1, and the margins are 20 and 80 with tabs at 30 and 40. The current carrier position is 20.

- The current carrier position represents the same carrier position on the margin/pitch scale. For example, if you position the orange pointer at 20 on the elite (12 Δ) margin scale, and then press the **Fmat** key, the current carrier position on the display is also 20.
- If no margins are set, the typewriter automatically sets a left and right margin at the carrier limits. For example, 0 (left margin) and 158 (right margin) for 12 pitch. Information similar to this is displayed:

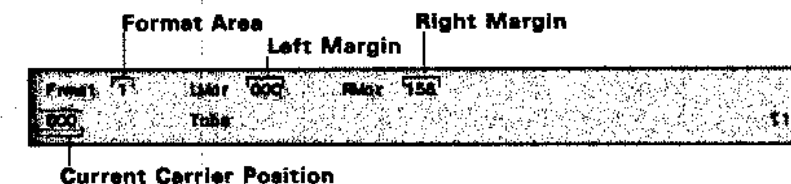

Selecting Format Settings

Use the Format function to save different margin and tab formats for different kinds of jobs. These formats can be used for jobs you type frequently, such as memos, reports, envelopes, and statistical charts. For example, you may want to save a format for typing envelopes: left margin 40, right margin 85, and no tabs.

The typewriter has nine areas reserved for formats. Use the Fmat key to select one of these areas as the current format. When you set margins and tabs, they are automatically saved in the current format area. The current format area is displayed when you press Fmat.

1. Hold down Fmat while you press a number (1 through 9) to select the desired format area.
 - The printwheel spins.
 - If you type the incorrect format number, press Fmat again; then type the correct number.
2. Release the keys.
3. Set the desired margins and tabs.
 - The margins and tabs you set are automatically saved in the format area that you selected in step 1.
4. Hold down the Fmat key to check the accuracy of your settings.
5. Repeat steps 1 through 4 for each different format area.

Selecting a Format Area

1. Hold down Fmat while you type the number of the desired format area.
2. Release the keys.
 - The margins and tabs are automatically set.
 - This format becomes the current format.
3. Type the job.

Practice

- Store the following margins and tabs in the format areas indicated below. Refer to steps 1 through 4 on page 1-24. You will use these formats as you complete the practices later in this manual.

Format Area 1: LMar 12 RMar 62 Tabs 15

Format Area 2: LMar 12 RMar 55 No Tabs

Format Area 3: LMar 12 RMar 44 No Tabs

Format Area 4: LMar 24 RMar 65 Tabs 51

Helpful Hints

- When you press Fmat, the current format is displayed.
 - If you change margins, the new margins will replace the previous settings in the current format area.
- Formats are automatically saved when the typewriter is turned off.

Correction Memory

Your typewriter has a correction memory that remembers approximately the last 4,000 characters (approximately one page) you type. The correction memory makes erasing characters very easy and automatic. The correction memory is present when you turn your typewriter on.

The correction memory is cleared if you:

- Turn the typewriter off.
- Use the **Paper Ball Load Lever** to insert or remove paper.
- Open storage.

Helpful Hints

- Use automatic erase to correct errors inside the correction memory. See "Erasing Automatically in 10, 12, and 15 Pitch" on page 1-27.
- If the typewriter does not automatically erase a character when you press the **Correction** key, you may be out of the correction memory. See "Erasing Manually in 10, 12, and 15 Pitch" on page 1-29.

Erasing Automatically in 10, 12, and 15 Pitch

Erasing a Character



Correction
Key

- Press the **Correction** key one time and one character is automatically erased.
- Press and hold down the **Correction** key to erase several characters.

Erasing a Word

1. Move the carrier to the incorrect word.
2. Hold down **Code** while you press the **Correction** key to erase the entire word.

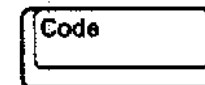

- The carrier may be positioned at any character in a word when you use **Word Erase**.
3. Type the correct word.

Note: If you remove the paper from the typewriter, use the **Paper Ball Load Lever** to reinsert the paper for corrections. Do not attempt to align the text on the paper with the display. You must use manual erase as explained on page 1-29.

Relocate Key



Press Reloc (Relocate) to return the carrier to the last typing position after you move the carrier to make a correction.

Practice

Type the following sentence.

Try the Reloc key to move to the last typing position.

1. Hold down **Code** while you press ← to move the carrier to the word *Try*.
2. Hold down **Code** while you press the **Correction** key to erase the word *Try*.
3. Type the word *Use*.
4. Press **Reloc** to return to the last typing position and continue typing.

Erasing Manually in 10, 12, and 15 Pitch

You may want to erase characters that are outside the correction memory. If the carrier is correctly positioned over the character when you press the **Correction** key, and the *printwheel spins but does not erase the character*, the carrier is outside the correction memory. You must use manual erase.

1. Move the carrier to position the printwheel pointer at the incorrect character.
 - Make sure the carrier is correctly aligned on the line of type and not between the lines. Use **Code + Paper Up** or **Code + Paper Down** for precise vertical alignment. Use **Code + Backspace** for precise horizontal alignment.
 - If you are erasing the entire word or several characters in the word, position the printwheel pointer at the last incorrect character in the word.

Example

Position Printwheel Pointer Here

You may need to erase one or several characters.

2. Press the **Correction** key. The printwheel spins.
3. Type the incorrect character exactly as it appears on your paper.
 - The incorrect character is erased.
4. Repeat steps 2 and 3 to manually erase each incorrect character.
 - You do not have to press **Backspace** when erasing from right to left. The carrier moves to the left when you type the next incorrect character.
5. Type the correct characters.

Helpful Hints

- If you are using a proportional spacing printwheel, see "Erasing in Proportional Spacing (PS)" on page 1-30.
- The **Bold Print** function must be on to manually erase bold text.
- The **Continuous Underline** function must be turned on to manually erase underlined text.

Erasing in Proportional Spacing (PS)

Read this section only if you have a proportional spacing (PS) printwheel. Do not complete this section if you are using a 10-, 12-, or 15-pitch printwheel. If you need help changing the printwheel, see pages 7-6 and 7-7.

In 10, 12, or 15 pitch, each character is allotted the same space. For example, an *l* takes up the same space as an *m*. In proportional spacing, the space allotted to each character depends on its width. The space is measured in units. For example, a lowercase *m* is seven units wide and a lowercase *l* is three units wide.

In proportional spacing, it is usually easier to erase the entire word containing an incorrect character, and then retype the word correctly. Use Word Erase as described on page 1-27 to erase the entire word quickly.

Erasing Manually in Proportional Spacing

You may need to erase characters that are outside the correction memory. You are typing outside the correction memory if your carrier is correctly positioned over the character when you press the Correction key, and the printwheel spins but does not erase the character. You must use manual erase.

When erasing manually, position the printwheel pointer at the left edge of each incorrect character. See the sample printwheel pointer on page 1-18.

Example



The diagram shows a horizontal row of five rectangular boxes, each containing a letter: 'T', 'i', 'm', 'e'. An upward-pointing arrow is positioned at the bottom center of the 'e' box, indicating the printwheel pointer's position.

Position the printwheel pointer here to erase the e.

1. Position the printwheel pointer at the left edge of the *last character* in the incorrect word.
2. Press the Correction key.
 - The printwheel spins.
3. Type the last character in the word exactly as you typed it the first time.
 - The character is erased.
 - If the incorrect character is not completely erased, hold down Code while you press Backspace (Bksp1) to reposition the printwheel pointer at the left edge of the *last character in the word*. Repeat steps 2 and 3.
4. Press the Correction key.
 - The printwheel spins and the carrier does not move.
5. Type the previous character in the word.
 - The carrier backs up and erases the previous character.
6. Repeat steps 4 and 5 for each character until the entire word is erased.
7. Type the correct characters.

Helpful Hints

- When using proportional spacing, always use the number 1. Do not use the lowercase letter *L* for the number 1.
- When erasing manually, always erase a word from right to left.
- When erasing manually, you only need to position the printwheel pointer at the left edge of the *last character in the word*. After you erase the last character, press the Correction key and type the previous character. This action moves the carrier and erases the previous character.

Inserting an Extra Character

When inserting an extra character in a word, use **Bksp1** to move the carrier one *unit* of space. The carrier moves back one unit of space each time you hold down **Code** while you press **Backspace (Bksp1)**.

1. Move the carrier to the incorrect word.
2. Hold down **Code** while you press the **Correction** key to erase the word.
3. Hold down **Code** while you press **Backspace (Bksp1)** two or three times to move the carrier back two or three units of space.
4. Type the correct word.

Practice

Type the first line of the example exactly as printed below. Follow the steps above to insert the *l* in the word *should*:

The letters shoud be
The letters be
The letters should be

Advanced Operations

Automatic Carrier Return

With Automatic Carrier Return on, the carrier automatically returns when you type a character following a space or hyphen near the right margin. You do not have to press the **CRtn** (Carrier Return) key when the typewriter reaches the right margin.

For some typing jobs, you will want to turn Automatic Carrier Return off. For example, do not use Automatic Carrier Return when typing tables, columns, or forms.

Note: If you are using Automatic Carrier Return and want the typewriter to beep near the right margin, then turn the **HYPHEN** indicator on. When the typewriter beeps, you can stop and decide if you want to hyphenate the word you are typing.

Turning Automatic Carrier Return/Hyphen On and Off

1. Hold down **Code** while you press **R (ARtn)** to turn Automatic Carrier Return on.
 - The **ARTN** indicator comes on.
2. Hold down **Code** while you press **R** again to turn Automatic Carrier Return and Hyphenation on.
 - The **HYPHEN** indicator comes on.
3. Hold down **Code** while you press **R** to turn Automatic Carrier Return and Hyphenation off.
 - The **ARTN** and **HYPHEN** indicators go off.

Practice

1. Insert a 12-pitch printwheel, then hold down **Format** while you press **F** to use the format you saved on page 1-25 (LMar 24 RMar 65).
2. Insert paper using the **Paper Ball Load Lever**.
3. Turn **Automatic Carrier Return** on.
4. Type the paragraph below.
 - Do not press **CRtn** at the end of the lines except where marked.

Example

Just keep typing and you will see when your new typewriter automatically returns the carrier for you. You can continue typing while the carrier is returning to the left margin.

CRtn

Helpful Hints

- The carrier does not return automatically if you type only spaces with the **Spacebar**, or type characters without spacing.
- You can continue typing while the carrier returns to the left margin.
- If you need to end a line before the right margin, press **CRtn**. Some examples of short lines are: date, inside address, salutation, short last line in a paragraph, closing, and short headings.
- While you are in the correction memory, the typewriter will not perform an automatic carrier return if text already exists on the following line, even though the **ARTN** indicator stays on.

Required Space and Required Hyphen

Sometimes you may *not* want the carrier to return automatically at the right margin because of the kind of text you are typing. For example, you may not want the carrier to return in the middle of names, dates, or certain numbers that must be kept on the same line.

If you type a required space or a required hyphen, the carrier will not return in the middle of text while you are typing with **Automatic Carrier Return** on.

- Hold down **Code** while you press **Spacebar** to type a required space.
- Hold down **Code** while you press **- (Hyphen)** to type a required hyphen.

Practice

Type the examples below with **Automatic Carrier Return** on. Insert a 12-pitch printwheel, then hold down **Format** while you press **F** to use the format you saved on page 1-25 (LMar 12 RMar 44).

Words typed *without* required spaces:

Victoria's birthday is January
22, 1988.

Words typed *with* required spaces:

	Code + Spacebar	Code + Spacebar
Victoria's birthday is January 22, 1988.		
		Right Margin

Words typed *without* required hyphens:

Bob's employee number is 123-
456-789.

Words typed *with* required hyphens:

	Code + -(Hyphen)	Code + -(Hyphen)
Bob's employee number is 123-456-789.		
		Right Margin

Underlining

You can automatically underline text continuously or one word at a time. The Continuous Underline function allows you to underline words and spaces as you type. You can also use the Word Underline function to underline one word at a time after you type it. The space after the word is not underlined.

Continuous Underline

1. Hold down **Code** while you press **U (Cont)** to begin underlining.
 - The **CONT** Indicator comes on.
2. Type the words to be underlined.
 - The words and spaces are underlined automatically as you type.
3. Hold down **Code** while you press **U** to end underlining.
 - The **CONT** indicator goes off.

Word Underline

1. Type the word to be underlined.
2. Hold down **Code** while you press **I (Word)**.
 - The carrier may be positioned at any character in a word when **Word Underline** is used.
 - The carrier backs up to the first character in the word and underlines the word.
 - **Word Underline** is automatically turned off after the word has been underlined.
3. Continue typing and repeat step 2 for each additional word you want to underline.

Useful Hints

You can use **Backspace**, **←**, or **↑** to return to words previously typed but still in the correction memory. Then, hold down **Code** while you press **I** to underline the words.

Centering

Text can be centered automatically between the left and right margins or at any point on a line.

Centering Between Margins

1. Make sure you have left and right margins set.
 - Press **Format** to check the margins. If you have not set a right margin, the typewriter automatically uses the right carrier limit as the right margin. In this case, text is centered between the left margin and the right carrier limit.
2. Press **CRtn** to move the carrier to the left margin.
3. Hold down **Code** while you press **C (Ctr)**.
 - The carrier moves to the center point between the margins.
 - The **CENTER** indicator comes on.
4. Type the text you want centered.
 - The carrier backs up without printing.
 - The text is displayed.
 - Use the **Correction** key to correct errors.
5. Hold down **Code** while you press **C**.
 - The text is centered and printed.
 - The **CENTER** indicator goes off.
 - Symbols are displayed on each side of centered text to show where centering begins and ends.

Example

|·| Centered Text |·|

Centering at Any Point on a Line

1. Move the carrier to the desired center point.
2. Hold down **Code** while you press **C**.
3. Type the text you want to center.
4. Hold down **Code** while you press **C**.

Helpful Hints

- Pressing **CRIn**, **Tab**, or **DecT** also causes text to print.
- To cancel centering before the text prints, press the **Correction** key until the **CENTER** indicator goes off.
- To erase centered text, you must erase all characters before you can erase the centering symbols from the display.
- You can center and underline text at the same time by using the **Center** and **Underline** functions together.
- The typewriter prevents you from typing over previously typed text and beeps each time you press a keybutton.
- The **Paper Up (Micro)**, **Paper Down (Micro)**, **↑**, **↓**, and **Backspace** keys do not work while **Centering** is on. The typewriter beeps when one of these keys is pressed.

Right Flush

The **Right Flush** function allows you to type text with an even (flush) right margin. You can right align text to the right margin or to any point on a line.

Example

XYZ Corporation
740 Anytown Road
Anytown, Ky 00110

Typing Right Flush Text to the Right Margin

1. Make sure you have left and right margins set.
2. Move the carrier to the left margin.
3. Hold down **Code** while you press **O (RFlsh)**.
 - The carrier moves to the right margin.
 - The **RFLUSH** indicator comes on.
4. Type the text to be aligned.
 - As you type, the carrier backs up without printing.
 - The text is displayed.
 - Use the **Correction** key to correct errors.
5. Hold down **Code** while you press **O**.
 - The text aligns and prints to the right margin.
 - The **RFLUSH** indicator goes off.
 - Symbols are displayed on each side of right flush text.

Example

⌈XYZ Corporation⌋

Typing Right Flush Text to Any Point on a Line

1. Move the carrier to the point where you want the text to be aligned to the right.
2. Hold down **Code** while you press **O**.
3. Type the text to be aligned.
4. Hold down **Code** while you press **O**.

Helpful Hints

- Pressing **CRtn**, **Tab**, or **DecT** also causes the text to print.
- The typewriter prevents you from typing over previously typed text and beeps each time you press a keybutton.
- The rightmost character prints *one space to the left* of the right margin or right flush point.
- The text will not appear to be right aligned if you type a space after the last character.
- To cancel Right Flush before the characters print, press the **Correction** key until the **RFLUSH** indicator goes off.
- You can type right flush text and underline at the same time by using the **Right Flush** and **Underline** functions together.
- The **Paper Up (Micro)**, **Paper Down (Micro)**, **↑**, **↓**, and **Backspace** keys do not work while **Right Flush** is on.

Subscripts and Superscripts

Subscripts are characters typed *below* the typing line (for example, CuSO_4). Superscripts are characters typed *above* the typing line (for example, *Happy Living*⁵).

Using the Subscript and Superscript functions, you can:

- Erase subscripts and superscripts automatically without moving the paper.
- View the subscript or superscript character and its symbol on the display with adjoining text. Text typed using **Code + Paper Up** and **Code + Paper Down** will not appear with adjoining text.

Typing Subscripts

1. Hold down **Code** while you press **H** ($\frac{1}{2}$ ↓).
 - The paper moves below the typing line.
 - A symbol is displayed where the subscript will print.

Subscript
Symbol
CuSO ↓

2. Type the subscript.
 - The paper moves back to the typing line.
 - The subscript is displayed as an overstrike.

Symbol
with
Overstrike
CuSO ↓

Typing Superscripts

1. Hold down Code while you press Y ($\frac{1}{2}$ ↑).
 - The paper moves above the typing line.
 - A symbol is displayed where the superscript will print.

Happy Living[†]

Superscript
Symbol

2. Type the superscript.
 - The paper moves back to the typing line.
 - The superscript is displayed as an overstrike.

Happy Living[†]

Symbol
with
Overstrike

Helpful Hints

- Do not use the paper movement keys to type subscripts or superscripts.
- Subscripts and superscripts cannot be underlined automatically. Underline them manually in Character or Delay Print using the Underline/Hyphen key.
- Automatic Carrier Return does not work on lines where the Paper Up (Micro) and Paper Down (Micro) keys are used to type a subscript.

Special Characters

Your typewriter has four special characters that you can type using the Code key: §, ¶, ², and ³. You can type these characters without changing the printwheel.

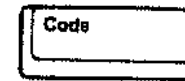

+



A section symbol (§) prints.

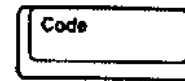

+



A paragraph symbol (¶) prints.

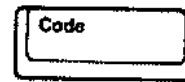

+



An exponent (²) prints.

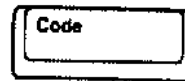

+



An exponent (³) prints.

Bold Print

Hold down Code while you press B (Bold) to turn Bold Print on or off.

- The BOLD indicator is displayed when Bold Print is turned on.
- A symbol is displayed above each character typed in bold.



- Text prints in bold as you type.

Helpful Hints

- Bold Print may be used in centering, decimal tab, and right flush text. For recommended readability in Bold Print, see "Printwheel Application Recommendations" on page 7-4.

Indenting

The Indent function allows you to set temporary left or right margins inside or outside the current margins. The temporary margins are used until the Indent function is turned off.

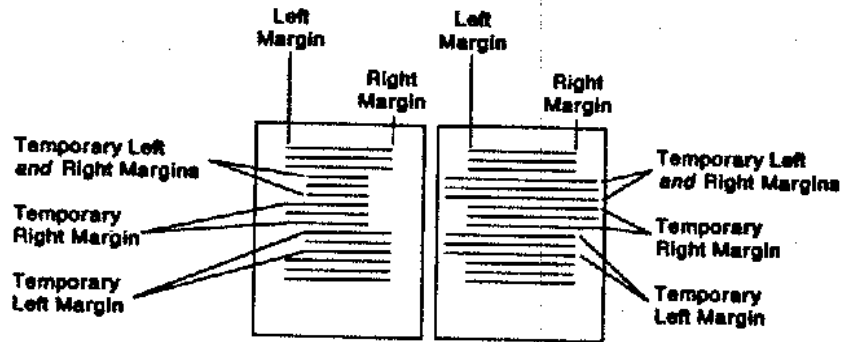

1. Type until you reach the *first* line to be indented.
2. If you want to set a temporary left margin, move the carrier to the desired temporary left margin position, then hold down Code while you press Tab (IndL).
 - A symbol is displayed to indicate that a temporary left margin has been set.
¶ For example, you can set
3. If you want to set a temporary right margin, use the Spacebar to move to the desired position.
4. Hold down Code while you press RMar (IndR) to set a temporary right margin.
 - A symbol is displayed to indicate that a temporary right margin has been set.
¶ For example, you can set
5. Press and hold ← to move to the left margin.
6. Type the indented lines.
7. When you finish typing the indented lines, hold down Code while you press CRtn (IndClr) to clear the temporary margins.
 - The carrier returns to the left margin.

Practice

1. Insert a 12-pitch printwheel, then hold down Fmat while you press 2 to use the format you saved on page 1-25 (LMar 12 RMar 55).
2. Turn Automatic Carrier Return on.
3. Follow the steps on the previous page to type the practice below.

Your new typewriter is designed to make typing easier and much more enjoyable.

Temporary Left Margin **Temporary Right Margin**

For example, you can set temporary left and right margins within a job when you want to indent lines of text.

Code + CRtn

try using temporary left and right margins to indent text in your jobs.

CRtn

Helpful Hints

- To cancel a temporary margin, press the Correction key until the indent symbol is cleared from the display.
- When revising a stored job (Chapter 3), a symbol is displayed to show where indented text ends.
lines of text. ¶
- After correcting typing errors in indented text, press Reloc to return the carrier to the last typing position. The carrier must be at the last typing position in order to clear the temporary left and right margins.



Decimal Tabulation

Use the Decimal Tab function to type numbers in vertical columns. You can align numbers on decimal points or at the column's right edge.

When using a proportional spacing (PS) printwheel to type numbers, always type the number 1 (on the numbers row). Never use the lower-case L for the number 1.

Typing Numbers with Decimals

Set Tab Here	Set Tab Here	Set Tab Here	Set Tab Here
234.56	456.79	1.32	1.50
2.87	20.13	.5	45.67

1. Turn Automatic Carrier Return off.
2. Set a tab for each column.
3. Move the carrier to the left margin.
4. Hold down **Code** while you press **D (DecT)** to move the carrier to the first tab stop.
 - The DEC T indicator comes on.
5. Type the numbers *up* to the decimal point.
 - The carrier moves backward but does not print.
6. Type the decimal point.
 - The numbers and the decimal point print.
 - The DEC T indicator goes off.
7. Type any numbers or characters that follow the decimal point.
8. Hold down **Code** while you press **D** to move to the next column.
 - Press **CRtn** after the last column at the end of each line.

Typing Numbers without Decimals

Set Tab Here	Set Tab Here	Set Tab Here	Set Tab Here
26,745	87,453	873	5%
387	3,498	34	234-

1. Repeat steps 1 through 4 above.
2. Type the number and any characters which follow it.
 - The carrier moves backward but does not print.
3. Hold down **Code** while you press **D**. The text prints and the carrier moves to the next decimal tab position.
 - Pressing **CRtn** or **Tab** also causes text to print.
 - If you press **CRtn**, the text prints and the carrier returns to the left margin.
 - If you press **Tab**, the text prints and the carrier moves to the next tab position. Decimal Tabulation is *off* at this point, and pressing **Code + D** moves the carrier to the *next* tab position for decimal tabulation.
4. Press **CRtn** after the last column at the end of each line.

Helpful Hint

- The **Paper Up (Micro)**, **Paper Down (Micro)**, **↑**, **↓**, and **Backspace** keys do not work while the Decimal Tab function is on.

Underlining Numbers in a Column

You may want to underline columns of numbers. Follow the steps below as you type the *last line* of numbers in each column.

1. Before typing the last line of the columns, hold down **Code** while you press **U** to turn Continuous Underlining on.
2. Hold down **Code** while you press **D**.
 - The carrier moves to the first tab stop.
3. Press **Spacebar** to type any underlined spaces in front of the number.
4. Type the number.
5. Hold down **Code** while you press **D** to move to the next column.
6. Continue typing each number by repeating steps 3 through 5.
7. Hold down **Code** while you press **U** to turn Continuous Underlining off.

Double Underlining Numbers in a Column

1. Repeat steps 1 through 7 above for the first underline.
2. Press **CRtn** after the last number.
3. To position the paper:
 - a. Press **↑** once.
 - b. Hold down **Code** while you press **Paper Up** twice.
4. To underline each column:
 - a. Move the carrier to the position where Underlining begins.
 - b. Hold down **Shift** while you press **- (Hyphen)** repeatedly to underline the numbers.
5. Repeat step 4 until all columns are underlined.
6. Hold down **Code** while you press **↑ (Line)** to realign to the previous typing line.
7. Press **CRtn**.

Choosing a Print Mode

Your typewriter has three print modes: Character Print, Delay Print, and No Print. You have been using Character Print so far.

Press the **Print Mode** key on the right side of the keyboard.



- Each time you press the key, the DL PRT (Delay Print) indicator or a blank (Character Print) is displayed. If you are working in storage (Chapter 3), the NO PRT (No Print) indicator is also displayed. Keep pressing **Print Mode** until you reach the mode you want to use.



Character Print means that the typewriter prints each character as you type it.

Delay Print causes the typewriter to delay printing until you reach the end of a typing line. This lets you type and make corrections *before* you print the text. This function is very helpful when you are filling out forms, especially forms using carbon paper. If text or display symbols (such as stop codes) already exist to the right of your current typing position, Delay Print is temporarily interrupted, even though the DL PRT indicator is still displayed.

No Print can be used only when you are working in storage. You will learn about Storage and No Print in Chapter 3.

Justification

Your typewriter can justify lines of text *evenly* at the right margin as you type.

1. Make sure left and right margins are set.
2. Press the **Jstlly** key to turn Justification on.
 - The **JSTIFY** and **DL PRT** indicators come on.
 - The **ARTN** and **HYPHEN** indicators are automatically turned off when **JSTIFY** comes on.
3. Type the text.
 - The text prints when you reach the right margin.
 - The text prints with an even right margin.
 - You can continue to type while the text is printing.
 - Lines typed with a carrier return are not justified. When Justification is on, the carrier automatically returns when it reaches the right margin. Press **CRtn** at the end of the last line of a paragraph.
4. Press the **Jstlly** key to turn Justification off.
 - The **JSTIFY** indicator goes off.
 - The typewriter returns to the print mode you had chosen before Justification was turned on.

Sample Printout

The sample below was typed using format area 1 as saved on page 1-25 (**LMar 12 RMar 62**).

Justified copy gives the appearance of a printed manuscript. Extra space is added automatically between words so that the right margin is even. Do not press the carrier return key while typing lines to be justified. If the last line of the job is a short line and should not be justified, press carrier return to end that line.

Helpful Hints

- Installing a printwheel to change the pitch or typestyle during justification may cause the left and right margins to be slightly uneven.
- Justification is not performed when text already exists on the line immediately below the current line.
- If you need to correct justified text, you must erase the incorrect text and then type the new text, adding spaces before and after words so that the text appears justified.

Changing Printwheels While Typing

You can use different printwheels while typing a job. The steps below explain changing printwheels when you are using *Delay Print*, *Centering*, *Right Flush*, or *Decimal Tab*. When you type in *Delay Print*, text does not print until you reach the right margin or press CRtn. When you use the *Centering*, *Right Flush*, or *Decimal Tab* functions, text does not print until you press a key that ends the function.

If you change the printwheel while typing *delay print*, *centered*, *right flush*, or *decimal tab* text, enter a stop code before you change the printwheel. The stop code stops the typewriter so you can change the printwheel during printing.

Using the Same Pitch with a Different Typestyle

Example (Changing Printwheels in Centered Text)

Code + 9 Code + 9 Code + C
Code + C Code + 9 Code + 9
IBM "Wheelwriter" Typewriter

1. Hold down **Code** while you press **C** to begin centering.
2. Type *IBM* and one space.
3. Hold down **Code** while you press **9** (**Stop**) to begin a stop code. The stop code comment message is displayed.

Ignore the message at this time. You will learn more about the message when using storage (Chapter 3).



4. Hold down **Code** while you press **9** to complete the stop code, then change the printwheel. See pages 7-6 and 7-7 if you need help.
5. Type *"Wheelwriter"* and one space.
6. Hold down **Code** while you press **9** two times. Change the printwheel.

7. Type *Typewriter*.
8. Hold down **Code** while you press **C** to end centering.
9. When the typewriter prints and stops at the stop code, the following symbols are displayed. Insert the correct printwheel.
--> <--
10. Press **End** to print to the next typestyle change.
11. Repeat step 9.
12. Press **End** to print the rest of the text.

Using a Different Printwheel Pitch

Stop codes are automatically entered when you change to a printwheel in a different pitch. When *Delay Print*, *centered*, *right flush*, or *decimal tab* text prints, the typewriter stops for a pitch change and the new pitch is displayed. For example, if you are typing in 12 pitch, the following indicator tells you to change to a 10-pitch printwheel:



- The **WHEEL** indicator blinks and then changes to reverse lettering.

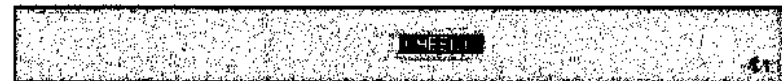

When you see the **WHEEL** indicator:

1. Insert the correct pitch printwheel.
2. Press **End** to continue printing.

Helpful Hints

- *Pitch* is the typestyle size based on the number of characters per horizontal inch. For example, 12 pitch means twelve characters per inch. See "Printwheel Identification" on page 1-18 and "Automatic Pitch Selection" on page 1-19.
- *Typestyle* is the name of a particular printwheel typeface. For example, *Prestige Elite* and *Script* are typestyle names. Typestyle samples are shown on pages 7-2 and 7-3.

Changing the Top Margin

You have already learned that when you insert paper using the paper ball load lever, the paper feeds to the top margin position. For some applications, you may want to change the position of the top margin (first writing line).

1. Insert a sheet of paper using the **Paper Ball Load Lever**. For more information, see "Inserting Paper" on page 1-12.
 - Always use the **Paper Ball Load Lever** to insert paper when changing the top margin. An incorrect top margin position will result if it is not used.
2. Use the **Paper Up**, **Paper Down**, **↓**, or **↑** keys to position the paper at the point where you want to set the new first writing line.
3. Hold down **Code** while you pull the **Paper Ball Load Lever** forward. The printwheel spins when the new top margin is set.
4. Push the **Paper Ball Load Lever** back to the closed position and release the **Code** key.

Helpful Hint

- The new top margin is saved when the typewriter is turned off.

Basic Storage

Storage Overview

You can store approximately 30,000 bytes (approximately 10 to 15 pages) in typewriter storage. With the Memory Expansion Option installed, storage can be expanded to approximately 60,000 bytes (approximately 20 to 30 pages). In addition, the Diskette Option adds virtually unlimited storage to the typewriter. Contact your IBM Authorized Dealer for details.

Note: Some character storage is used for other typewriter actions such as spacing, carrier returns, and document control functions.

Storage

Storing jobs is similar to filing documents in a file cabinet. To use a file cabinet, you open the cabinet, place the document in a file, then close the cabinet. To store a job, you open a storage area, type a job, then close the storage area.

When you are storing a job, you will find it helpful to pay attention to the display. The display shows what you have typed and presents messages and indicators to help you.

Each storage area can contain one word, a paragraph, or several pages of text. When a storage area is open, the **STORE** indicator is displayed and anything you type is stored. When storage is closed, the **STORE** indicator is not displayed.

Typing jobs into storage allows you to add, delete, or revise text later without retyping the entire job. If you use Automatic Carrier Return when storing and playing back the job, your line endings are adjusted to show your revisions. Use required hyphens and required spaces to keep phrases together on one line regardless of their position in the job; for example, *brother-in-law* and *January 22*.

Storing a Job

Opening Storage

1. Always prepare the typewriter *before* you open storage: Insert paper using the **Paper Ball Load Lever**; install the desired printwheel; press **Format** to check margins and tabs; and check the line spacing.
2. Hold down **Store** while you type a number (1 through 99) to open a storage area. The number you type identifies the storage area you opened.
 - The **STORE** and **ARTN** indicators come on.
 - If the **PLAY** indicator comes on, text has already been stored in the storage area.

Typing Into Storage

Type the job. Everything you type is remembered.

- When the **ARTN** indicator is on, the carrier automatically returns at the end of each full line of typing. Leave **Automatic Carrier Return** on unless you are working with columns or tables. Use stop codes as explained on page 3-30 to remind you when to turn **Automatic Carrier Return** off or on within a job.
- For jobs requiring margin changes, refer to "Margin and Tab Formats in Stored Jobs" on page 3-8.
- Use the **Correction** key to erase incorrect characters, spaces, or carrier returns you notice immediately. When you finish correcting text, press **Reloc** to move the carrier to the last typing position.

Closing Storage

Press **Store**.

- Tabs, margins, and indented margins are automatically stored with the job.
- The carrier moves to the left margin.
- The **STORE** indicator goes off, indicating that the storage area is closed.

Practice

1. Insert a 12-pitch printwheel, then hold down **Format** while you press **2** to use the format you saved on page 1-25 (**LMar 12 RMar 55**).
2. Store the paragraph below in storage area 1. If storage area 1 already contains text, close the storage area and open another.
 - Press **CRtn** only where indicated.
 - Correct only errors that you notice immediately.

Store + a number (1 through 99)

In the late nineteenth century, a period in history marked by the beginnings of the industrial revolution and the development of new technologies, typing contests drew enthusiastic spectators and provided free advertising for a struggling typewriter industry. In those days, typing speeds of 40 to 45 words per minute were considered astonishing. **CRtn**

Store

3. Press **Store** to close the storage area at the end of the paragraph.
4. Hold down **Play** while you press **1** to play back the job.

Helpful Hints

- When you close a storage area, the carrier moves to the left margin. If you did not press **CRtn** at the end of your job, the paper also moves up one line when you press **Store**. This carrier return is not stored with the job.
- When you open a storage area, the typewriter continues using the print mode that was active before storage was opened.
- Line space changes are not stored with the job.

Playback Overview

Using the **Play** key, you can print stored jobs, copy jobs to other storage areas, make revisions, or combine jobs (Chapter 5). Playback can be used with storage open or closed. Corrections made during playback with storage closed are not stored with the job.

You can stop playback and then type, make corrections, resume playback, cancel playback, or play back another job. When you play back a job with storage closed, the job prints bidirectionally (the first line prints left to right, the second line prints right to left, and so forth).

You can play back a draft copy of a job with double spacing and the final copy with single spacing because the line space setting is not stored with the job.

Playing back multipage jobs is made easier because the typewriter allows you to set page length and then stops playback at the preset point. For more information, see "Page-Layout" on page 4-10 and "Auto Page End" on page 4-13.

You can also move tab settings (columns) during playback. See "Tab Adjust" on page 4-15 for more information.

Playing Back a Stored Job

There are two ways to play back a stored job. Jobs can be played back with storage open or with storage closed.

- When you play back with storage *open*, the job plays back using the same margins and tabs it was stored with.
- When you play back with storage *closed*, the current margin settings are used if Automatic Carrier Return is on.

If you want to use the same margins that were used when the job was stored, you can reset the margins to match the ones stored with the job.

Playing back a job with storage closed is explained below. See "Revising a Stored Job Using Character or Delay Print" on page 3-15 for information on playing back with storage open.

Beginning Playback

1. Install the correct printwheel.
2. Set the margins.
 - Jobs are played back from storage using the *current margin settings*. Press **Format** to check current left and right margins.
 - If you want to set the original margins for playback, use the **Directory** function as explained on page 4-3 to view the margin settings stored with the job, then set the margins.
 - If you do not want to use the current or original margins, set new margins of your own.
3. Position the carrier at the point where you want playback to begin.
4. Set Automatic Carrier Return on or off.
 - When Automatic Carrier Return is *on* during playback, lines are ended according to the current margin settings.
 - When Automatic Carrier Return is *off* during playback, your job plays back line for line as you stored it.
5. Set line spacing.
6. Hold down **Play** while you type the number where you stored the job.
7. Release the keys. Playback begins immediately.
 - The **PLAY** indicator comes on.
 - The first line of the job plays from left to right; the second line of the job plays from right to left, and so on.
 - The **PLAY** indicator goes off when playback is complete.

Stopping Playback

Press any key to stop playback.

- If you stop playback while the typewriter is printing *left to right*, the current line of text is displayed and the cursor rests on the *next character to be printed*.



- If you stop playback while the typewriter is printing *right to left*, the typewriter finishes printing the current line, the carrier moves to the left margin, and the paper moves up one line. The next line of text is displayed. The cursor rests on the first character of the line.

Continuing Playback

Press one of the following keys to continue playback:

- → plays back the next character.
- Code + → (Word) plays back the next word.
- ↓ plays to the end of the current line.
- End plays to the end of the job.
 - If the carrier is at the right limit, press CRtn, then press End to continue playback.

Canceling Playback

1. Press any key to stop playback.
2. Press Play to cancel playback.
 - The PLAY indicator goes off.
 - Text already printed from the current line is displayed.

If you accidentally cancel playback:

1. Press Play.
 - The PLAY indicator is displayed.
 - The current line of text is displayed and the cursor rests on the next character to be printed.
2. Continue playback.

Practice

1. Install the same pitch printwheel and set the same line space you used when you stored the job on page 3-3.
2. Play back the job. Practice starting, stopping, canceling, and playing back by line, word, and character.
 - You can play back the job as many times as you wish.

Helpful Hints

- If you press CRtn while typing a job, the carrier returns at that point during playback.
- Text is not displayed during playback.

Margin and Tab Formats in Stored Jobs

Use the Format function as described on pages 1-23 through 1-25 to set margins and tabs to be used for the jobs you store. The following guidelines will help you use format areas within your stored jobs.

Before Opening Storage

Select the format area to be used for the job *before* opening an empty storage area. You cannot select another format area while in storage. The format area you select is not affected by changing margins and tabs in storage.

After Opening Storage

When an empty storage area is opened, the format you selected is automatically copied to format area 0.

When **Fmat** is pressed in storage, format area 0 is displayed, along with the current margin and tab settings. If you change the margin and tab settings while in storage, the new settings will be displayed when you press **Fmat**. The job is stored with the *new* margins and tabs, but the *format area* you selected is not changed. Format area 0 acts as a *working* format area to keep you from accidentally altering a *saved* format area.

- One left margin and one right margin is stored with the job.
- Set tabs and temporary margins wherever needed. All tab settings and temporary margins are stored with the job.

After opening a storage area that already contains text, the stored margins and tabs are displayed when you press the **Fmat** key.

Changing Margins and Tabs After Opening Storage

1. Press **Play** to turn the PLAY indicator off if it is on.
 - Text which has not printed is temporarily cleared from the display.
2. Use the **Spacebar** and the **Backspace** key to move to the desired positions, and use **LMar**, **RMar**, and **TSet** to set margins and tabs.
 - If you press **LMar** while in storage, the following message is displayed:

USE IndL OR PRESS LMar AGAIN TO RESET DOCUMENT MARGIN OR **CE** TO CANCEL

- Use **IndL** to set a temporary left margin.
- Use **LMar** to change the left margin for the *entire* job. That is, the left margin for the text you have already typed will change to the new left margin when you play back the job.
- Press the **Correction** key if you do not want to set new margins. Indented text remains indented.
- If you press **RMar** while storage is open, the following message is displayed:

USE IndR OR PRESS RMar AGAIN TO RESET DOCUMENT MARGIN OR **CE** TO CANCEL

- Use **IndR** to set a temporary right margin.
 - Use **RMar** to change the right margin for the *entire* job. That is, the right margin for the text you have already typed will change to the new right margin when you play back the job.
 - Press the **Correction** key if you do not want to set new margins. Indented text remains indented.
3. Press and hold **←** to return to the left margin.
 4. Press **Play** to turn the PLAY indicator back on.
 - The current line of text is displayed and the cursor rests on the next character to be printed.

Practice

Store the following example, setting margins and temporary margins as indicated.

LMar 12

RMar 52

The Indenting function allows you to change your margins within a job. Margins may be moved outside or inside their original settings.

IndL 22

IndR 52

"If you wish to change either the left or right or both margins after you have started a job, always use the Indent function to make the change."

IndL 10

Code + CRtn

1. Always use the Indent function to make margin changes to your job.

IndL 7

Code + CRtn

IndR 67

Changing the margins with the STORE indicator off will not change the stored job. Changing the margins with the STORE indicator on will change the margins for the entire job.

Code + CRtn

Typing Hyphens in a Stored Job

Syllable Hyphens

If you are storing a job and want to hyphenate a long word at the right margin, insert a *syllable hyphen* as in this example:

Type - (Hyphen)

Press CRtn

Our department has considered your application for review.

Remember, you must press CRtn after typing the syllable hyphen.

If the sentence is played back later with different margins and Automatic Carrier Return on, the hyphen will be automatically dropped if it is not needed.

Practice

1. Insert a 12-pitch printwheel, then hold down Fmat while you press 2 to use the format you saved on page 1-25 (LMar 12 RMar 55).
2. Open an empty storage area.
3. Type the sentence in the example up to the hyphen after *applica*.
4. Type the hyphen (-).
5. Press CRtn.
6. Type the rest of the example.
7. Close storage.
8. Make sure Automatic Carrier Return is on and play back the job to see if it matches the example.
9. Hold down Fmat while you press 3 to use the format you saved on page 1-25 (LMar 12 RMar 44).
10. Make sure Automatic Carrier Return is on and play back the job. Your copy should resemble the following:

Our department has considered your application for review.

Helpful Hint

After typing the hyphen, if you continue typing the word and let the carrier return automatically, the hyphen will *not* be dropped if the word occurs in the middle of the line during playback. Your copy will resemble the following:

Our department has considered
your applica-tion for review.

Permanent Hyphens

There are two ways to type hyphens to ensure that they will always play back with the text. The hyphenated word can be kept on one line or allowed to automatically separate if the text is played back later using different margins.

Keeping a Hyphenated Word on One Line

Hold down **Code** while you type a hyphen in words or numbers you always want kept together on one line. (If you want the typewriter to beep near the right margin, turn the HYPHEN indicator on when you are typing the job.)

Code + - (Hyphen)

The number to call for assistance is 1-800-555-1212.

Allowing Hyphenated Words to Separate at a Line Ending

Make sure that Automatic Carrier Return is on. Type a hyphenated word without pressing **CRIn** and without pressing **Code**. The following example contains hyphens that may break automatically at the right margin.

A special visitor to our country is our mother-
in-law.

Practice

1. Insert a 12-pitch printwheel, then hold down **Format** while you press **1** to use the format you saved on page 1-25 (LMar 12 RMar 82).
2. Open an empty storage area.
3. Type the examples below.

Code + - (Hyphen)

The number to call for assistance is 1-800-555-1212.

A special visitor to our country is our mother-
in-law.

4. Close storage.
5. Make sure Automatic Carrier Return is on and play back the job to see if it matches the example.
6. Hold down **Format** while you press **3** to use the format you saved on page 1-25 (LMar 12 RMar 44).
7. Make sure Automatic Carrier Return is on and play back the job. Your copy should resemble the following:

The number to call for assistance
is 1-800-555-1212.

A special visitor to our country
is our mother-in-law.

Revision Overview

Revisions are made to jobs when storage is open. Revisions can be made on paper using Character Print or Delay Print, or on the display using No Print.

When revising on paper (Character Print or Delay Print), use **Play** to print the job to the revision point. Add, delete, or make corrections to the text at that point and resume playback. Your revisions are stored just as they appear on the paper. Use Character Print to revise tables and columns.

When revising in No Print, you can move quickly to a revision point without printing the job. The display shows the text and symbols that indicate typewriter functions such as tabs, centering, right flush, and so on. In No Print, you can insert or delete text anywhere in the job without printing it. The **Del** key works in combination with the paper and cursor movement keys in No Print to give a wide range of control over deleting text.

If you type or print text in Character or Delay Print and then change to No Print, the carrier moves to the left margin. This indicates that the display and the text already on paper no longer match. If you return to Character Print to revise the text on the paper, replay the text before making revisions.

Copying a Job for Revision

All revisions are stored with your job. Therefore, you may want to make a copy of your job before beginning revisions so that you will always have the original job for use later, if necessary. To copy a job quickly:

1. Hold down **Store** while you type the number of an *empty* storage area.
2. Select No Print.
3. Hold down **Play** while you type the number of the job you want to copy.
4. Press **Store** to close the storage area.

Revising a Stored Job Using Character or Delay Print

Playing to the Revision Point

1. You may want to make a copy of your job before making revisions. See "Copying a Job for Revision" on page 3-14 for more information.
2. Install the same pitch printwheel and set the same line space you used when you stored the job.
 - Position the carrier at the point where you want playback to begin.
3. Hold down **Store** while you type the number of the job to be revised.
 - The ARTN, STORE, and PLAY indicators are displayed.
4. Make sure Character Print or Delay Print is on.
5. Press **End** to begin playback.
6. Press any key to stop playback before the revision point.

Adding Text to the Job in Character or Delay Print

As you add text to a stored job, the words on the display move to the right automatically as new text is inserted.

Note: Turn the ARTN indicator off just before revising tables or columns. Turn the ARTN indicator on again after revising the table or columns. For more information, see page 3-30.

1. Play to the revision point.
2. Make sure the PLAY and STORE Indicators are on. Press →, Code + →, or ↓ to continue playback up to where you want to add text.
 - If you play past the point where you want to add text, use the Correction key to erase back to the correction point.
 - If you turn the PLAY indicator off, the → and ↓ keys no longer cause text to print. The → and ↓ keys provide express movement to add spaces and lines to your job. Turn the PLAY indicator on again to resume playback with the → and ↓ keys.
3. Type the text you want to add. If you are adding a word, type a space after it.
 - Watch the display. As you type new text, the old text moves over.
 - In Character Print, new text prints as you type it.
 - In Delay Print, the new text does not print immediately. The carrier moves forward and the new text is displayed. The text prints when you continue playback.
4. Type any text you erased.
5. Press →, Code + →, ↓, or End to continue playback.

Deleting Text from the Job in Character or Delay Print

When you delete information, the typewriter automatically closes up the space. You can delete a character, a word, a line, or from some point to the end of the job.

Use the Del key in combination with a function key to delete text.

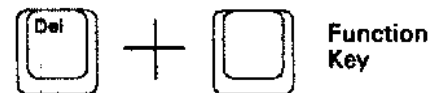

Note: Turn the ARTN indicator off just before revising tables or columns. Turn the ARTN indicator on again after the table or columns. For more information, see page 3-30.

1. Stop playback before the correction point. Hold down Code while you press → to play one word at a time up to the text you want to delete.
2. Delete text before it prints using one of the following combinations of keys:
 - Del + → deletes the character the cursor is resting on. The cursor moves forward to the next character.
 - Del + Code + → deletes from the cursor to the end of the word, including any punctuation and spaces that follow the word. The cursor moves to the first character of the next word.
 - Del + ↓ deletes from the cursor to the end of the line, including the carrier return. Since the display does not always show a full line of text, make sure you are not deleting too much before you press Del + ↓. The cursor moves to the first character of the next line.
 - Del + End deletes from the cursor to the end of the job. The following message is displayed:

PRESS DEL AGAIN TO DELETE OR PRESS C TO CANCEL

- Press Del to delete the text.
- Press the Correction key to cancel Delete and return to the text display.

3. Use either of the following keys to delete text from the paper and the display:
 - Press the **Correction** key to erase one character at a time.
 - Hold down **Code** while you press the **Correction** key to erase one word at a time, including punctuation and spaces.
4. Press **→**, **Code + →**, **↓**, or **End** to continue playback.

Practice

1. You may want to copy your job before making revisions. See page 3-14 for details.
2. Install the same pitch printwheel and set the same line space you used when you stored the job on page 3-3.
3. Hold down **Store** while you type the number of the job you stored on page 3-3.
4. Select **Character** or **Delay Print**.
5. Press **↓** to play back one line at a time until three lines have printed. Do not play back the fourth line yet. Your playback should resemble the following:

In the late nineteenth century, a period in history marked by the beginnings of the industrial revolution and the development

6. Hold down **Code** while you press **→** to play up to the word **contests**. Your paper should resemble the following:

In the late nineteenth century, a period in history marked by the beginnings of the industrial revolution and the development of new technologies, typing

7. Type the word **speed**, followed by a space.
8. Press **↓** to finish playing back the fourth line, then continue pressing **↓** until the seventh line has printed. Do not play back the eighth line yet. Your paper should resemble the following:

In the late nineteenth century, a period in history marked by the beginnings of the industrial revolution and the development of new technologies, typing speed contests drew enthusiastic spectators and provided free advertising for a struggling typewriter industry. In those days, typing speeds of

9. Hold down **Code** while you press **→** to play up to the word **to**. Your paper should now resemble the following:

In the late nineteenth century, a period in history marked by the beginnings of the industrial revolution and the development of new technologies, typing speed contests drew enthusiastic spectators and provided free advertising for a struggling typewriter industry. In those days, typing speeds of 40

10. Hold down both **Del** and **Code** while you press the **→** key two times. The word **45** and the word **to** are deleted from the job and the display.
11. Press **End** to continue playback to the end of the job, then close storage. Your paper should resemble the following:

In the late nineteenth century, a period in history marked by the beginnings of the industrial revolution and the development of new technologies, typing speed contests drew enthusiastic spectators and provided free advertising for a struggling typewriter industry. In those days, typing speeds of 40 words per minute were considered astonishing.

12. Press **Store** to close storage.

Correcting Errors with Storage Closed

Corrections made while playing back with the STORE Indicator off are not stored with the job. The corrections will not appear the next time you play back the job.

The procedures used in correcting errors during playback with storage closed are the same as those used in "Revising a Stored Job Using Character or Delay Print" on page 3-15. The only exception is that a storage area is not opened. Therefore, only a brief outline of the procedures is given below. For more information, see page 3-15.

Beginning Playback

1. Prepare the typewriter.
2. Hold down **Play** while you type the number where you stored the job.
 - The job plays back bidirectionally.
3. Press *any key* to stop playback before the correction point.
 - If you stop playback while printing right to left, printing stops at the end of the current line.

Adding Text to the Job

1. Play up to the point where you want to add text.
 - Press **→** to play one character at a time.
 - Press **Code + →** to play one word at a time.
 - Press **↓** to play one line at a time.
2. Type the text.
3. Continue playback.

Deleting Text from the Job

1. Play up to the text you want to delete.
 - Press **→** to play one character at a time.
 - Press **Code + →** to play one word at a time.
 - Press **↓** to play one line at a time.
2. Use the **Del** key in combination with the **→**, **↓**, or **End** keys to delete the text from the display.
3. Use the **Correction** key or **Code + Correction** key to erase text from the paper and the display.
4. Continue playback.

Revising a Stored Job Using No Print

Using No Print, you can revise your job on the display and in storage without printing it. You can play back a final copy after all revisions have been made. No Print allows you to move to the revision point quickly and saves paper and ribbon.

The display shows the text and symbols that indicate the use of typewriter functions such as tabs, centering, right flush, and so on.

Opening Storage

1. Hold down **Store** while you press the number where you stored the job to be revised.
 - The ARTN, STORE, and PLAY indicators are displayed.
2. Press **Print Mode** until the NO PRT indicator is displayed.
 - The PLAY indicator goes off.

Moving through Storage

Use any of the following keys to move the *cursor* through storage to the desired point:

- **→** moves the cursor one character to the right.
- **Code + →** moves the cursor one word to the right.
- **←** moves the cursor one character to the left.
- **Code + ←** moves the cursor one word to the left.
- **↓** moves the cursor to the beginning of the next line.
- **Code + ↓** moves the cursor forward across blank lines to the next line of text.
- **↑** moves the cursor to the beginning of the previous line.
- **Code + ↑** moves the cursor backward across blank lines to the next line of text.
- **End** moves the cursor to the end of the job.
- **Home** moves the cursor to the beginning of the job.

Notes:

1. If you have difficulty finding text on the display, use **Code + ↓** or **Code + ↑** to move across blank lines to the next line of text.
2. Do not use **CRtn** or **Spacebar** to move through storage unless you want to insert blank lines and spaces into the job.

Adding Text in No Print Mode

Note: Use Character Print to revise tables and columns

1. Use the ↓ or ↑ key to move the cursor to the beginning of the line where you want to add text.
2. Use →, ←, Code + →, or Code + ← to move the cursor to the point on the line where you want to add text.
 - For example, to add a word between *typing* and *contests*, move the cursor so that it rests on the letter *c* in *contests*.

```
of new technologies, typing contests draw
```

3. Type the text you want to add.
 - Use the Correction key if you type an incorrect character.
 - Type all necessary spaces and punctuation when adding text. For example, when adding the word *speed* between the words *typing* and *contests*, type a space after *speed*.

```
of new technologies, typing speed contests draw
```

Deleting Text in No Print Mode

Note: Use Character Print to revise tables and columns.

1. Move the cursor to the point where you want to delete text.
2. Delete text using one of the following combinations of keys:
 - Del + → deletes the character the cursor is resting on. The cursor moves forward to the next character.
 - Del + ← deletes the character the cursor is resting on. The cursor moves backward to the previous character.
 - Del + Code + → deletes from the cursor to the end of the word, including any punctuation and spaces that follow the word. The cursor moves to the first character of the next word.
 - Del + Code + ← deletes from the cursor to the beginning of the word, but *does not* delete the space preceding the word. The cursor moves to the space that preceded the deleted word.
 - Del + ↓ deletes from the cursor to the end of the line, including the carrier return. Since the display does not always show a full line of text, make sure you are not deleting

too much before you press Del + ↓. The cursor moves to the first character of the next line.

- Del + End deletes from the cursor to the end of the job. The following message is displayed:

```
PLEASE Del AGAIN TO DELETE OR PRESS C TO CANCEL
```

- Press Del to delete the text.
- Press the Correction key to cancel Delete and return to the text display.

Deleting Extra Carrier Returns

If extra carrier returns appear in your job, you can delete them just as you delete any other character from the display. The carrier returns play back on your paper as extra white space. Each carrier return is displayed as a symbol.

Example of Extra Carrier Returns on the Display:

```
Dear Ms. Jones: [ ] [ ] [ ] [ ]
```

Example of Extra Carrier Returns on Paper:

```
Dear Ms. Jones:  
Extra  
Carrier  
Returns {  
Thank you for your  
interest in our services.
```

To delete the carrier returns:

1. Move the cursor or play to the point where extra carrier returns appear.
2. Hold down Del while you press → to delete one carrier return.
3. Repeat steps 1 and 2 until all the extra carrier returns are deleted.
4. When you are finished revising the job, close storage.

Practice

1. Insert a 12-pitch printwheel, then hold down **Format** while you press **2** to use the format you saved on page 1-25 (LMar 12 RMar 55).
2. Install the same pitch printwheel and set the same line space you used when you stored the job on page 3-18.
3. Open the storage area where you stored the job on page 3-18.
4. Select **No Print**.
5. Move the cursor to the fourth line of the job and delete the word *speed*.
6. Move the cursor to the eighth line of the job and add the words to 45 after the number 40.
7. Close storage and play back a final copy of the job. Your final copy should resemble the following:

In the late nineteenth century, a period in history marked by the beginnings of the industrial revolution and the development of new technologies, typing contests drew enthusiastic spectators and provided free advertising for a struggling typewriter industry. In those days, typing speeds of 40 to 45 words per minute were considered astonishing.

Storage Rules

Follow these rules when storing jobs to ensure the best results for revising and playing back.

- Use the **Paper Ball Load Lever** and the paper release lever instead of **↑** and **↓** to insert and remove paper. This will prevent you from inserting unwanted blank lines in your stored job.
- While in **No Print**, use the **Cursor Movement Keys** when moving around in storage. Do not use the **CR** or **Spacebar** keys unless you want to insert blank lines or spaces in your job.
- Use the *Indent function* instead of changing left and right margins within a job. The *Indent function* is described on page 2-12.
- **Automatic Carrier Return** should be turned off when typing columns or tables within a job. See page 3-30 for tips on turning **Automatic Carrier Return** off while storing a job.
- **Automatic Carrier Return** should be turned on for all text except columns and tables if you plan to make revisions later. If **Automatic Carrier Return** is not used when typing into storage, revised text will not play back correctly.
- Use **Character Print** for typing columns and tables.
- Use *stop codes* to give titles to your jobs and to indicate where changes such as **Justification**, **Automatic Carrier Return**, line spacing, typestyle or ribbon changes occur in your job.
- Multipage jobs can be stored in a single storage area. The *Auto Page End function* is used to separate pages within a job during playback. See "Auto Page End" on page 4-13 for more information.
- Use tabs instead of spaces to separate columns in a job. This enables you to move columns to the right or left easily with the *Tab Adjust function*. **Tab Adjust** is described on page 4-15.
- Use multiple carrier returns instead of changing line spacing between paragraphs. Changing line spacing is explained on page 3-30.

Playback Rules

Refer to these rules when playing back different types of jobs.

- Always set correct *line spacing* before beginning playback.
- Play back a job with *storage closed* when you do not want to store the changes.
- Play back a job with *storage open* to *revise it*. Your changes are stored with the job.
- If the WHEEL Indicator is displayed at playback, the number following the indicator shows the pitch used when the job was stored. For example, if WHEEL 12 is displayed when you are using a 10-pitch printwheel, you have three choices:
 1. Install a 12-pitch printwheel to play back the job exactly as it was stored.
 2. Use the 10-pitch printwheel and play back the job with *Storage closed*. The job remains stored as a 12-pitch job.
 3. Use the 10-pitch printwheel and play back the job with *Storage open*. The job is stored as a 10-pitch job.

When jobs are stored in proportional spacing and played back in 10, 12, or 15 pitch, they may not play back exactly as you typed them.

- When playing back a job using an *alternate keyboard*, printing stops where the keyboard change occurred and the KYBD indicator comes on. The WHEEL indicator comes on to prompt you to check that the correct printwheel is installed for the alternate keyboard. Install the correct printwheel and press **End** to continue printing. The typewriter automatically selects the new keyboard. For more information, see "Using Alternate Keyboards" on page 6-2.

Revision Rules

Refer to these rules when revising different types of jobs.

- Play back a job with *storage open* to revise it.
- Make a copy of the job before beginning to revise it.
- Use the Cursor Movement Keys when moving around in storage. Do not use **CRtn** or **Spacebar** unless you want to insert blank lines or spaces in your job.
- If you type or print text in Character or Delay Print and then change to No Print, the carrier moves to the left margin. This indicates that the display and the text already on paper no longer match. If you return to Character Print to revise the text on the paper, replay the text before making revisions.
- Turn Automatic Carrier Return on except for portions of the job that contain columns or tables.
- Use stop codes to give titles to your jobs and to indicate where changes such as Justification, Automatic Carrier Return, line spacing, and typestyle or ribbon changes occur.
- Play back the job with *storage open* to adjust the line endings after making all revisions.
- Use Character Print to revise columns and tables.
- In No Print, when revising centered or right flush text that was typed at the left margin, do not insert spaces or characters before the text.

Deleting Stored Jobs

1. Hold down **Del** while you press the number where the job is stored.
 - A message similar to this is displayed:

PRESS **Del** AGAIN TO DELETE STORAGE 2 OR PRESS **Esc** TO CANCEL

t1

In the example above, the 2 is the number of the storage area you are about to delete.

2. Press **Del** to delete the storage area.

Canceling Delete

When the message is displayed, press the **Correction** key to cancel delete.

Deleting All Storage Areas

Warning: This procedure clears all storage and format areas and turns off all typewriter functions.

1. Hold down both **Code** and **Shift** while you press **Del**.
 - The following message is displayed.

PRESS **Del** AGAIN TO DELETE ALL STORAGE AREAS OR PRESS **Esc** TO CANCEL

t1

2. Press **Del** to delete all storage areas.
 - The **STORAGE CLEARED** message is displayed.
 - All storage areas are cleared.

Using Stop Codes in Storage

Type a stop code at any point in a job where you want playback to stop automatically. You may want to stop playback to type text as a job prints or to change typewriter settings such as line spacing or Automatic Carrier Return. See page 3-30 for stop code applications.

Typing a Stop Code

1. Type text or move the cursor to the point where you want the typewriter to stop during playback.
2. Hold down **Code** while you press **9 (Stop)** to begin a stop code.
 - The following message is displayed:

TYPE STOP CODE COMMENT:

t1

- You may type a short comment (up to 50 characters) describing what to do at this point during playback. The comment is displayed but not printed when typed or played back.
3. Hold down **Code** while you press **9** to end the stop code. The stop codes and comments are displayed as follows:

Stop Code
Symbol

Stop Code
Symbol

Ⓢ Change Line Spacing to 2Ⓢ

4. Proceed as instructed by the stop code comment, then continue typing.

Playing Back a Job That Contains a Stop Code

1. Play back the job as instructed in "Playing Back a Stored Job" on page 3-4.
2. When playback reaches the stop code, printing stops and the stop code comment is displayed with symbols before and after it.

Stop Code
Symbol

Stop Code
Symbol

-->Change Line Spacing to 2<--

3. Read the comment and respond.
4. Press **End** to continue playback.

Deleting a Stop Code

1. Make sure storage is open.
2. Select **No Print**.
3. Move the cursor to the first stop code symbol.
4. Press the **Correction** key.
 - The stop code and the stop code comment are deleted.

Stop Code Applications

Reminder to Turn Automatic Carrier Return Off and On

Type a stop code at any point in a job where you want to turn Automatic Carrier Return off. For example, when you want to turn Automatic Carrier Return off for tables, columns of numbers, or forms, type a stop code at the point where Automatic Carrier Return should be turned off. Type another stop code at the point where you want to turn Automatic Carrier Return on again.

Reminder to Change Line Spacing

Type a stop code at any point in a job where you want to change line spacing. For example, you may want to change from double spacing to single spacing for long quotes within a report. Type a second stop code at the point where you wish to return the line spacing to its original setting.

Form Letters

Type a stop code at each point where variable information should be typed in a form letter. For example, you can type a stop code at the point where the date and inside address will appear. You can type stop code comments to remind you what information should be typed at each position.

Job Titles

Type a stop code at the beginning of every stored job with a brief description of the job in the stop code comment. When you play back the job with storage closed, the comment appears first, allowing you to verify that this is the job you want to play back. When you play back the job with storage open, the typewriter ignores the stop code at the beginning of the job.

Reminder to Turn Justification On or Off

Type a stop code before any portion of a job that should be justified. In the comment, remind yourself to turn Justification on. Type another stop code at the point where you want to turn justification off.

Reminder to Change Printwheel

When storing a job, you must type a stop code before a typestyle change so that the typewriter will stop to allow you to change the printwheel. The typewriter automatically stores a stop code when you change to a different pitch. Refer to "Changing Printwheels While Typing" on page 2-20.

Keyboard Changes

The typewriter automatically inserts stop codes at keyboard changes in your job. During playback, the KYBD indicator comes on to indicate that a new keyboard is going to be selected.

Menu Functions

The Menu key gives you access to several special functions on your typewriter, including:

- A directory of all the jobs in storage. Jobs can be played back, revised, or deleted through the directory.
- A printed list of stored jobs.
- A Page Layout function to adjust the number of lines per page for printing multipage jobs.
- A Tab Adjust function so you can move tab positions during play-back so columns and tables can print in a new position on the page.
- The ability to view and delete words from the Spell Check II supplemental dictionary. (See Appendix A.)

If you have the Diskette Option, you can open diskette storage areas through Menu as well.

Identifying the Current Storage Area

While typing in storage, you may want to know which storage area is open.

1. Press Menu.
 - The menu is displayed. The number to the right of the message is the storage area that you are presently using.

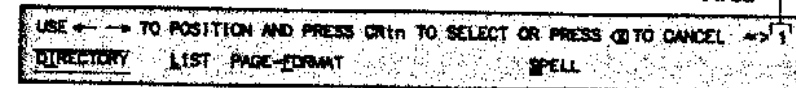

2. Press Menu or the Correction key to cancel menu.

Using the Menu Key

The Menu key can be used with the STORE indicator on or off.

1. Press Menu. The following information is displayed:

```
USE ← → TO POSITION AND PRESS CRtN TO SELECT OR PRESS C TO CANCEL
DIRECTORY LIST PAGE-FORMAT SPELL
```

- DIRECTORY displays the jobs stored in typewriter storage areas, the amount of storage space for each job, the left and right margin settings for each job, and the remaining storage space.
 - LIST prints a copy of the directory. For more information, see "List" on page 4-8.
 - PAGE-FORMAT allows you to set the number of lines that print on each page of your job and adjust the tab settings in a stored job. For more information, see "Page-Layout" on page 4-10, "Auto Page End" on page 4-13, and "Tab Adjust" on page 4-15.
 - SPELL allows you to view and delete words from the Spell Check II supplemental dictionary. For more information, see "Viewing and Deleting Words from the Supplemental Dictionary" on page A-5.
2. You may select a menu function in two ways:
 - Move the cursor to the desired function, then press CRtN to select the function; or
 - Type the underlined character in the desired function. For example, type I to view DIRECTORY or L to print a LIST of directory contents. The text may be typed in uppercase or lowercase. When you type the underlined character, the function is automatically selected.
 3. Press Menu or the Correction key to cancel Menu.

Directory

The Directory menu function displays a list of the jobs in the typewriter storage areas. The amount of storage space used by each job, the left and right margins for each job, and the amount of storage space remaining are also displayed. The directory can also be used to store, play back, or delete text.

1. Press Menu. The following information is displayed:

```
USE ← → TO POSITION AND PRESS CRtN TO SELECT OR PRESS C TO CANCEL
DIRECTORY LIST PAGE-FORMAT SPELL
```

2. Select DIRECTORY. Information resembling the following is displayed:

```
USE ↑ ↓ TO POSITION AND PRESS Store, Play OR Del KEY 30174
Letter to Bob Meyer 012:090 109
```

- The number in the upper right corner of the display is the amount of storage space remaining in typewriter memory; for example, 30174.
- If the STORAGE EMPTY message is displayed, you have no jobs in storage.
- The number in the lower right corner on the second line of the display indicates the amount of storage space used for that job; for example, 109.
- The number at the left on the second line is the storage area where the job is stored; for example, 1.
- If you typed a heading (*title*) for your job using stop codes as described on page 3-31, it is displayed also. Otherwise, the first 50 characters of the job are displayed.
- Job numbers are displayed only for storage areas that contain text.
- The numbers 012:090 are the *margin settings*: 012 is the left margin, and 090 is the right margin. The settings are automatically recalculated to match the pitch of the printwheel in the typewriter. Therefore, if you stored the job using a 12-pitch printwheel, but currently have a 10-pitch printwheel installed, the settings displayed are for the 10-pitch printwheel. Use these settings to set margins before playing back the job.

3. Use the ↑ and ↓ keys to continue moving through the directory.
 - Only two lines of the directory are displayed at a time.
4. Press **Home** to return to the beginning of the directory.
5. Press **End** to view the last two lines of the directory.
6. Press **Menu** or the **Correction** key to cancel Directory.

Revising a Job through the Directory

1. Follow the instructions on page 4-3 to view the directory and move to the job you want to revise.
2. When the cursor is at the job you want to revise, press **Store**.
 - The first line of the job is displayed.
3. Revise the job as instructed on page 3-15.

Playing Back a Job through the Directory

1. View the directory and move to the job you want to play back.
2. When the cursor is at the job you want to play back, press **Play**.
 - The **PLAY** indicator comes on.
 - The job automatically plays back.
 - To stop playback, press any key.
 - To resume playback, press **End**, ↓, or →.
 - To cancel playback, press any key to stop playback, then press **Play** until the **PLAY** Indicator goes off.
3. When playback is complete, the **PLAY** indicator goes off.

Deleting a Job through the Directory

1. View the directory and select the job you want to delete.
2. When the cursor is at the job you want to delete, press **Del**. Information similar to the following is displayed:

```

PRESS DEL AGAIN TO DELETE STORAGE. 1 OR PRESS CLR TO CANCEL
T Letter to Bob Myers 012:080 108
  
```

3. Press **Del** to delete the job.
 - Each time a job is deleted, the Directory reappears.
 - If all jobs are deleted, the **STORAGE CLEARED** message is displayed.
 - To cancel delete, press the **Correction** key.
4. Repeat steps 2 and 3 for each job you want to delete.
5. Press **Menu** or the **Correction** key to cancel Directory.

Locating Job Numbers in the Directory

You can use **Find** with Directory to move to a specific job. You will learn more about the **Find** function in Chapter 5.

1. Press **Menu**.
2. Select **DIRECTORY**.
3. Hold down **Find** while you type the number of the job you want to locate.
 - If the selected job does not exist, the next highest number is selected.

List

Use the List function to print a copy of the directory. All job numbers, titles, margins, the amount of storage space used by each job, and the amount of remaining storage space is printed.

1. Make sure paper is in the typewriter.
2. Set the left margin at one inch to ensure that the list does not print off the right edge of the paper.
3. Press **Menu**. The following information is displayed:

```
USE ← → TO POSITION AND PRESS CRTR TO SELECT OR PRESS CE TO CANCEL
D|IRECTORY  LIST PAGE-FORMAT      SPELL
```

4. Select **LIST** to print the directory.
 - The display is cleared while the directory prints.
 - The printed list should be similar to the example below:

```
30518
  1 (Letter to Bob Meyer)          012::090  109
  2 In the late nineteenth centur  020::070  210
```

- The margin settings are automatically recalculated to match the pitch of the printwheel in the typewriter. Therefore, if you list the job with a 10-pitch printwheel installed one time and with a 12-pitch printwheel installed another time, the settings will be different.
- If the listed directory is more than one page:
 - a. Press any key to stop playback at the end of the current line. The following message is displayed:

```
PRESS END TO CONTINUE OR PRESS CE TO CANCEL
```

- b. Use the paper release lever to remove paper.
- c. Use the **Paper Ball Load Lever** to insert a new sheet of paper.
- d. Press **End** to resume printing the list.
 - Press the **Correction** key to cancel List.

Helpful Hints

- When **LIST** is selected, the correction memory is cleared.
- The print mode setting does not affect directory printing.
- The directory prints with the current line spacing.
- The directory prints using the current keyboard. Jobs typed using other keyboards are printed incorrectly. For more information, see "Alternate Keyboards" on page 6-1.
- Auto Page End is inactive during printing of the directory. For more information, see "Auto Page End" on page 4-13.

Storage Full

The storage capacity of your typewriter is approximately 30,000 bytes (approximately 10 to 15 pages). Therefore, each stored job subtracts from the available capacity.

Note: This typewriter's storage capacity may be expanded to approximately 60,000 bytes (approximately 20 to 30 pages) of storage space and a Diskette Option may be added for virtually unlimited storage. Contact your IBM Authorized Dealer for further details.

Storage Full Warning

When storage is almost full:

- The typewriter beeps three times.
- The STORE indicator blinks, then changes to reverse lettering.



You have space for about 100 more characters.

1. Stop typing. *Do not* close storage.
2. Do one of the following:
 - *Without closing storage*, delete a storage area you no longer need (see "Deleting a Job through the Directory" on page 4-5); or
 - Press **Store** to close the storage area and continue typing. The rest of your job will not be stored.

Storage Full Message

If the typewriter beeps on every keystroke and the STORAGE FULL message is displayed, storage is full. Follow the instructions in "Storage Full Warning."

Page-Format

The Page-Format function allows you to select the Page-Layout function and turn the Auto Page End and Tab Adjust functions on or off.

Page-Layout is used to set the number of lines per page and the bottom margin to be used when playing back a multipage job. When Auto Page End is on during playback, the typewriter automatically stops printing at the end of each page based on the Page-Layout settings.

The Tab Adjust function allows you to reset the tab positions for your job. Therefore, you can move columns or tables in your job to the right or left. Your tab positions can be reset and stored with the job or changed for playback only.

To select PAGE-FORMAT:

1. Press **Menu**. The following information is displayed:

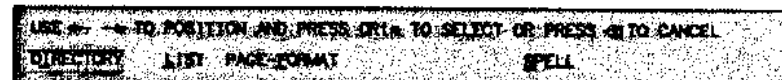

2. Select PAGE-FORMAT. The following information is displayed:

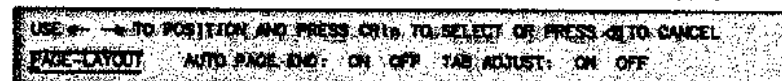

Page-Layout

Use Page-Layout to describe the paper you are using in the typewriter. The only time you need to change the Page-Layout settings is when you change the length of the paper you are using or the bottom margin.

Setting Page Length and Bottom Margin

1. Press Menu. The following information is displayed:

```
USE ← → TO POSITION AND PRESS CRtn TO SELECT OR PRESS C TO CANCEL
DIRECTORY LIST PAGE-FORMAT SPELL
```

2. Select PAGE-FORMAT. The following information is displayed:

```
USE ← → TO POSITION AND PRESS CRtn TO SELECT OR PRESS C TO CANCEL
PAGE-LAYOUT AUTO PAGE END: ON OFF TAB ADJUST: ON OFF
```

3. Select PAGE-LAYOUT. The following information is displayed:

```
PAGE LENGTH: 88 BOTTOM MARGIN: 6
PRESS CRtn TO SELECT OR PRESS C TO CANCEL
```

- If the current page length and bottom margin are correct, press CRtn to select the numbers. "Calculating Page Length and Bottom Margin" on page 4-11 explains how to calculate page length and bottom margin settings.
4. Type the desired number of lines for page length.
 - If you type an incorrect number, press the Correction key to erase it, then retype the number.
 - If you do not want to change the bottom margin setting, press CRtn to select the numbers.
 5. Press → to move the cursor to the bottom margin setting.

```
PAGE LENGTH: 88 BOTTOM MARGIN: 6
PRESS CRtn TO SELECT OR PRESS C TO CANCEL
```

6. Type the desired number of lines for the bottom margin.
 - If you type an incorrect number, press the Correction key to erase it, then retype the number.
 - If the bottom margin setting is greater than the page length setting, the typewriter beeps.
7. Press CRtn to select the numbers you have typed.

Calculating Page Length and Bottom Margin

If you have not previously set Page-Layout, the typewriter assumes you are using 11-inch paper with a one-inch bottom margin. Therefore, if you are using a 10-, 12-, or PS-pitch printwheel, the page length will be 66 lines and the bottom margin will be 6 lines. For a 15-pitch printwheel, the settings will be 88 and 6. The typewriter automatically recalculates the Page-Layout settings when you change pitch.

Printwheel pitch determines the number of lines per inch. For example, 10-, 12-, and PS-pitch printwheels print six lines of text per vertical inch, while 15-pitch printwheels print eight lines of text per vertical inch.

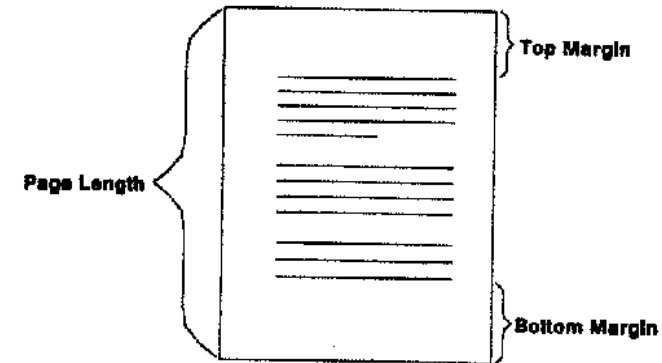

Page length is the number of single-spaced lines on a page. Page length is determined by multiplying the length of the paper in inches by the number of lines per inch.

The *bottom margin setting* is the distance in lines from the last line of text to the end of the page.

The *top margin* is set by the paper bail load lever. The top margin is set at approximately one inch unless you have programmed the paper bail load lever differently. If the top margin setting is incompatible with the Page-Layout settings, the typewriter assumes a top margin of zero during playback.

Page-Layout settings are saved when you turn the typewriter off.

Common Page-Layout Settings for Paper Length

Paper Length (Inches)	Page Length (Lines) 10, 12, PS Pitch	Page Length (Lines) 15 Pitch
11	66	88
14	84	112

Common Page-Layout Settings for Bottom Margin

Bottom Margin (Inches)	Bottom Margin (Lines) 10, 12, PS Pitch	Bottom Margin (Lines) 15 Pitch
½	3	4
1	6	8
1½	9	12
2	12	16

Page-Layout Settings for Pinwheel Form Feeder

Important: Read this section *only* if you have the Pinwheel Form Feeder Option installed on your typewriter.

When you use your typewriter as a printer for your computer, the computer controls the page length settings. However, when you use the machine as a typewriter with a *Pinwheel Form Feeder*, you must set the Page-Layout settings as follows:

- Set *top margin* (**Code + Paper Ball Load Lever**) where you want the first line of text to print, for example, two lines from the top of the page.
- Set *page length* to the number of single-spaced lines per page, for example, 66.
- Add the amount you allowed for the top margin (two lines) to the amount you want for the bottom margin (six lines, for example) and enter the *total* as your *bottom margin* (eight lines).

Auto Page End

The Auto Page End function automatically separates pages of a multi-page job during playback. When Auto Page End is on, the typewriter uses the Page-Layout settings to determine page length and bottom margin.

Before turning Auto Page End on, check the Page-Layout settings. See page 4-10 if you need help.

Turning Auto Page End On

1. Press **Menu**.
2. Select **PAGE-FORMAT**.
3. Press **→** one time to move the cursor to **ON**.

USE ← TO MOVE CURSOR AND PRESS **CRtn** TO SELECT OR PRESS **Q** TO CANCEL
PAGE-LAYOUT: AUTO PAGE END: ON OFF TAB ADJUST: ON OFF

4. Press **CRtn**. The display is cleared and the **APAGE** indicator comes on.

Playing Back a Job with Auto Page End On

When Auto Page End stops playback at the bottom of the page:

1. The typewriter beeps three times and the **END OF PAGE REACHED** message is displayed.
2. Use the paper release lever to remove paper.
3. Use the **Paper Ball Load Lever** to insert a new sheet of paper.
4. Press **End** to continue playback.

Turning Auto Page End Off

1. Press **Menu**.
2. Select **PAGE-FORMAT**.
3. Press **→** two times to move the cursor to **OFF**.

```
USE ← → TO POSITION AND PRESS CRtn TO SELECT OR PRESS Q TO CANCEL
PAGE-LAYOUT AUTO PAGE END: ON OFF TAB ADJUST: ON OFF
```

4. Press **CRtn**.
 - The display is cleared and the **APAGE** indicator goes off.
 - When Auto Page End is off, the typewriter does not stop at the end of a page unless a required page end or stop code occurs.

Helpful Hints

- Use the **Paper Ball Load Lever** to insert paper.
- Auto Page End does not allow the first line of a paragraph to be the last line on a page, and continues playback for one line past the bottom margin to finish a paragraph.
- When storing a job, use a **Required Page End (Code + E)** after short pages of text to force a new page.
- If a job does not play back properly, check your **Page-Layout** settings. Also check the top margin set by the paper ball load lever.
- If the top margin setting is incompatible with **Page-Layout** settings, the typewriter assumes a top margin of zero during playback.
- The line space setting does not affect the page length setting.
- You can change pitch without resetting **Page-Layout**.
- Auto Page End is temporarily turned off if a mark occurs which moves past the end of the page. For more information, see "Using Mark for Preprinted Forms" on page 5-24.

Tab Adjust

Use the **Tab Adjust** function to control how text typed with tabs is played back. **Tab Adjust** allows you to move columns and tables on the page. For example:

Stored Job

	Tab	Tab
Lexington, KY	40505	606
Owensboro, KY	42301	502
Rockville, MD	20854	301

Stored Job After Tab Adjust

	Tab	Tab
Lexington, KY	40505	606
Owensboro, KY	42301	502
Rockville, MD	20854	301

When **Tab Adjust** is turned **OFF**, the tab settings in the current format area do not affect the tab settings of a stored job. Suppose a job was stored with a left margin of 10 and tabs at 20 and 35. If you play back this job with the left margin at 10, the tabs will always be at 20 and 35. When the tabs in the current format area are at 40 and 50, the stored job still plays back with tabs of 20 and 35. The current format area does not affect the tab settings of the stored job.

The tabs in a job are stored relative to the left margin. In the example above, if you change the left margin at playback to 15, the tabs will play back at 25 and 40. The tabs are still the same distance from the left margin as when you stored the job. That is, the tabs are still 10 and 25 spaces from the left margin. The tabs in the job have not changed; only the left margin changed.

With the **Tab Adjust** function turned **ON**, the typewriter moves the tabs in the job from the stored settings to the current settings.

Turning Tab Adjust On

1. Press **Menu**. The following information is displayed:

USE ← → TO POSITION AND PRESS CRtn TO SELECT OR PRESS ⏏ TO CANCEL.
D I R E C T O R Y L I S T P A G E - F O R M A T S P E L L

2. Select **PAGE-FORMAT**. Press → three times to move the cursor to **ON**.

USE ← → TO POSITION AND PRESS CRtn TO SELECT OR PRESS ⏏ TO CANCEL.
P A G E - L A Y O U T A U T O P A G E E N D : O N / O F F T A B A D J U S T : O N / O F F

3. Press **CRtn** to turn **TAB ADJUST** on.
 - The **T ADJ** indicator is displayed.

Turning Tab Adjust Off

1. Press **Menu**. The following information is displayed:

USE ← → TO POSITION AND PRESS CRtn TO SELECT OR PRESS ⏏ TO CANCEL.
D I R E C T O R Y L I S T P A G E - F O R M A T S P E L L

2. Select **PAGE-FORMAT**.
3. Press → four times to move the cursor to **OFF**, then press **CRtn**.

USE ← → TO POSITION AND PRESS CRtn TO SELECT OR PRESS ⏏ TO CANCEL.
P A G E - L A Y O U T A U T O P A G E E N D : O N / O F F T A B A D J U S T : O N / O F F

- Tab Adjust is canceled and the **T ADJ** indicator goes off.

Moving Tabs During Playback

Follow these steps to play back a job with new tab settings. These new settings are not permanently stored.

1. Make sure the **STORE** and **ARTN** indicators are turned off.
2. Turn **TAB ADJUST** on.
3. Press **Frmat** to check the format area. Set the desired tabs using **TSet** and **TCir**.
4. Hold down **Play** while you press the number of the job to be played back with new tabs.
 - The **PLAY** indicator comes on and the job plays back.
 - When playback is complete, the **PLAY** indicator goes off.
 - The **T ADJ** indicator is displayed until Tab Adjust is turned off.

Moving Tabs throughout a Stored Job

Follow these steps to store your job with new tab settings. These new settings are permanently stored.

1. You may want to copy your job before adjusting tabs. See page 3-14 for details.
2. Make sure the **STORE** and **PLAY** indicators are off.
3. Turn **TAB ADJUST** on.
4. Hold down **Store** while you press the number of the job to be stored with new tabs.
 - The **STORE** and **PLAY** indicators come on.
5. Select **Character** or **Delay Print**. Tabs are adjusted only **In Character** or **Delay Print**.
6. Press **Frmat** to check the tabs in the stored job.
 - Set the desired tabs using **TSet** and **TCir**. See page 3-9 for more information.
7. Press one of the following keys to begin playback:
 - → to play back one character at a time.
 - ↓ to play to the end of the current line.
 - End to play to the end of the job.
8. Press **Store** when playback is complete.
 - The **STORE** and **PLAY** indicators go off.
 - The job is stored with new tab settings.
 - The **T ADJ** indicator is displayed until Tab Adjust is turned off.
9. Turn **TAB ADJUST** off.

Practice

1. Insert a 12-pitch printwheel, then set the following margins and tabs in format area 5: LMar 12 RMar 72 Tabs 48, 60.
2. Store the text below in storage area 25. If storage area 25 already contains text, close the storage area and open another.

Example

	Tab	Tab
Lexington, KY	40505	606
Owensboro, KY	42301	502
Rockville, MD	20854	301

3. Close storage, then play back the job.
4. Clear all tabs, then play back the job. Your printed copy will be identical to the first copy you printed.
5. Set the following tabs: 24, 36, 48, 60. Play back the job. Your printed copy will be identical to the first copy you printed.
6. Clear all tabs, then set the following tabs: 36, 48. Your printed copy will be identical to the first copy you printed.
7. Turn Tab Adjust on, then play the job. The columns on your printed copy will move to the new tabs.

Moving Tabs in a Portion of a Stored Job

By turning Tab Adjust on and off during playback, you can change the tab settings for a portion of the job.

1. Make sure the STORE and PLAY Indicators are off.
2. Press **Format** to check the current margins and tabs.
 - Set the same margins you used when you stored the job.
 - Set tabs at the desired *new* positions.
3. Select Character Print.
4. Play the job through the tabs that are to remain unchanged.
 - Use ↓ to play one line at a time.
5. When you reach the part of the job containing tabs you want to move, turn Tab Adjust ON.
6. Play those lines containing tabs that should move.
 - Use ↓ to play one line at a time.
7. Turn Tab Adjust OFF.

Practice

1. Insert a 12-pitch printwheel, then set the following margins and tabs in format area 6: LMar 12 RMar 84 Tabs 36, 60.
2. Store the text below in storage area 26. If storage area 26 already contains text, close the storage area and open another.

Store	Directory	Find
Playback	List	Change
Revise	Page-Format	Mark
Hyphenate	Page-Layout	Document Assembly
Stop Codes	Auto Page End	Justification
Deleting Jobs	Tab Adjust	

3. Close the storage area.
4. Clear all tabs. Set new tabs at 30 and 48.
5. Play through the third line (Revise, Page-Format, Mark) of the job you stored in step 2.
6. Turn Tab Adjust ON.
7. Play the rest of the job. Notice that the second and third columns have moved.
8. Turn Tab Adjust OFF.

Helpful Hints

- Be sure to turn Tab Adjust off after using it.
- Only tabs that are actually played back are adjusted in storage.
- Only text that was typed after a tab will move. If spaces or tabs and backspaces were used instead of tabs to separate columns, the text will not be moved by Tab Adjust.
- Permanent tabs exist at the left and right margins. These tabs cannot be cleared.

Advanced Storage

Justification during Playback

Jobs can be played back with the JSTIFY indicator on for an even right margin (as in a newspaper). You must set left and right margins before justifying a job during playback. Use the Directory function as explained on page 4-3 to view the margin settings used in the stored job.

Sample Justification Printout

Justified copy gives the appearance of a printed manuscript. Extra space is added automatically between words so that the right margin is even. Do not press the carrier return key while typing lines to be justified. If the last line of the job is a short line and should not be justified, press carrier return to end that line.

Practice

1. Insert a 12-pitch printwheel, then hold down **Format** while you press **1** to use the format you saved on page 1-25 (LMar 12 RMar 62).
2. Open an empty storage area and type the sample printout on page 5-1.
 - Space only one time between words.
 - Do not press **CRtn** except at the end of the last line of text.
3. Close storage.
4. Press the **Justify** key.
 - The **JSTIFY** and **DL PRT** indicators are displayed.
5. Hold down **Play** while you type the number where the job is stored. Playback begins immediately.
 - Lines which are ended by pressing **CRtn** will not be justified.
6. When the job has played back, press **Justify** to turn Justification off.

Helpful Hints

- Justification should be turned off for portions of jobs containing tables.
- Do not store footnotes, page headings, or page numbers with the job since revisions may cause page endings to change.

Hyphenation during Playback

You can hyphenate words during playback so your job prints with a more even right margin.

When the **HYPHEN** indicator is on during playback, the typewriter stops printing where a word will print beyond the right margin. The typewriter beeps and the **HYPHEN** indicator blinks several times, then changes to reverse lettering. The cursor blinks at the first character in the word to be hyphenated. Do one of the following when the typewriter stops for hyphenation:

- Hyphenate the word.
- Keep the word on the same line.
- Move the word to the next line.

Hyphenations made with storage closed are not stored with the job. If the job is played back with storage open, the hyphenations are stored with the job. When you play back the job with the same margins and the **HYPHEN** indicator on, the words you hyphenated play back hyphenated. If the margins have been changed and a previously hyphenated word prints in the middle of a line, the hyphen is dropped.

Turning Hyphenation On

Hold down **Code** while you press **R** until the **HYPHEN** indicator comes on.

- The **ARTN** and **HYPHEN** indicators are displayed.

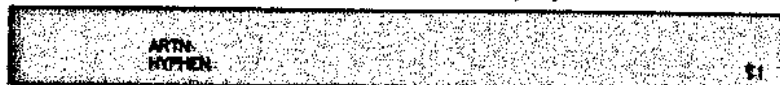

Hyphenating the Word

1. When the typewriter stops during playback, press **→** to play back characters until you hear a beep. This beep indicates that you are at the right margin.
2. Continue pressing **→** until you play to the desired hyphenation point.
 - If you play past the hyphenation point, use the **Correction** key to erase back to the hyphenation point.
3. Type the hyphen.
4. Press **CRtn**.
 - Retype any characters you erased.
5. Press **End** to continue playback.

Keeping the Word on the Same Line

When the typewriter stops during playback, press **End** to continue playback.

- The word stays on the same line.

Moving the Word to the Next Line

1. When the typewriter stops during playback, press **CRtn**.
 - The word is moved to the next line.
2. Press **End** to continue playback.

Practice

1. Insert a 12-pitch printwheel, then hold down **Format** while you press **1** to use the format you saved on page 1-25 (**LMar 12 RMar 62**).
2. Hold down **Code** while you press **R** until the **HYPHEN** indicator is displayed.
3. Hold down **Play** while you type the number of the job you stored on page 3-24. Playback begins immediately.
4. When the typewriter stops for a hyphenation decision, do one of the following: hyphenate the word, keep the word on the same line, or move the word to the next line. Refer to page 5-4 if you need help.

Notice the display when playback stops; the **HYPHEN** indicator changes to reverse lettering if there is a long pause while waiting to make a hyphenation decision. The reverse lettering is a reminder to make the decision. See the example of reverse lettering below:

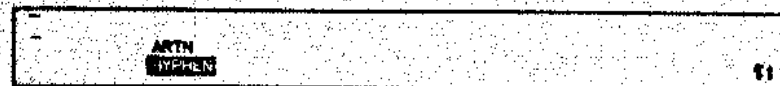

5. Repeat this practice until you are comfortable with hyphenation. The hyphens are not stored because storage is closed.

Sample Printout

In the late nineteenth century, a period in history marked by the beginnings of the industrial revolution and the development of new technologies, typing contests drew enthusiastic spectators and provided free advertising for a struggling typewriter industry. In those days, typing speeds of 40 to 45 words per minute were considered astonishing.

Helpful Hints

- If you type a syllable hyphen to divide a word, always press **CRtn**, then press **End** to continue playback. When the job is played back, the hyphen is dropped if the word occurs in the middle of a line. If you do not press **CRtn** before pressing **End**, the hyphen becomes a permanent hyphen. The next time you play the job, the hyphen prints in the middle of the word.
- If a word containing a permanent hyphen must be divided at the end of a line, play back the word until the desired hyphen has printed, then press **End** to continue playback.

Using Find

The **Find** key allows you to search for a revision point or particular text in a stored job quickly. Using **Find**, you can move directly to a specific word or line to change, replace, delete, or add text to a job. You can also use **Find** to advance, play, or delete to a specific point.



Advancing To a Find Point

1. Hold down **Store** while you type the number of the storage area you want to open.
 - The **ARTN**, **STORE**, and **PLAY** indicators are displayed
2. Press the **Find** key. The following message is displayed:



3. Type the text that you want to find (up to 24 characters) *exactly* as it appears in your stored job.
 - When searching for the word *the*, your typewriter also finds occurrences of the words *then*, *these*, *lathe*, and so on. Use punctuation, capitalization, or spaces before and after the word to make specified text unique.
 - Use the **Correction** key to correct any typing errors.
4. Press **End** to search from the current position to the *end* of the job.
 - You can also press **Find**, **↓**, or **→** to search to the end of the job.
 - If you are using **No Print**, you can also press **Home**, **↑**, or **←** to search to the beginning of the job.
5. The typewriter finds the next occurrence of the specified text in the direction you indicated. When the text is displayed, make revisions according to the Instructions in Chapter 3.

Note: If the typewriter stops for a hyphenation decision, printwheel change, or stop code while you are using **Find**, the **Find** function is canceled. **Find** is also canceled if you press any key during a **Find** operation.

Repeating Find

1. Press Find.
 - The last text you specified is displayed.
2. When the message is displayed, do one of the following:
 - To repeat Find without specifying new text to search for, continue with step 3.
 - Type new text to search for over the old text. The old text is automatically removed from the display when you type the first character of the new text.
3. Press End to search from the current position to the end of the job.
 - You can also press Find, ↓, or → to search to the end of the job.
 - If you are using No Print, you can also press Home, ↑, or ← to search to the beginning of the job.
4. The typewriter finds the next occurrence of the specified text in the direction you indicated. When the text is displayed, make the revisions.

Practice

1. Insert a 12-pitch printwheel, then hold down Fmat while you press 2 to use the format you saved on page 1-25 (LMar 12 RMar 55).
2. Hold down Store while you type the number of the job you stored on page 3-24.
3. Select No Print.
4. Press the Find key.
5. Type the word *typewriter*.
6. Press End.
7. Delete the word *typewriter* and add the phrase *office equipment*.
8. Press the Find key.
9. Type the word *beginnings*.
10. Press Home.
11. Delete the word *beginnings* and add the phrase *first years*.

12. Close storage when you finish revising the job.
13. Play back a copy of the revised job. Your printed copy should resemble the example below:

In the late nineteenth century, a period in history marked by the first years of the industrial revolution and the development of new technologies, typing contests drew enthusiastic spectators and provided free advertising for a struggling office equipment industry. In those days, typing speeds of 40 to 45 words per minute were considered astonishing.

Helpful Hints

- If the TEXT NOT FOUND message is displayed:
 - Make sure you typed the text *exactly* as it appears in the stored job.
 - Make sure the cursor is not already on the text you want to find.
 - Repeat Find and press End, then repeat Find and press Home to make sure you have searched the entire job.
- Press any key to clear the TEXT NOT FOUND message from the display.
- If you specify to find more than 24 characters, the typewriter beeps and ignores each additional character you type.
- Many alternate keyboards contain accent marks that are dead keys that print without advancing the carrier to the next space. To find text containing accent marks, type the character but not the accent mark. For example, to find *résumé*, type *resume*.

Playing to a Find Point

Combine Find with Play to play to a particular point in a stored job.

1. Hold down **Store** while you press the number of the job you want to play back.
2. Press the **Find** key.
3. Type the text that you want to play to.
4. Press **End**. The job plays to the text you specified.

Deleting to a Find Point

Combine Find with Delete to delete to a particular point in a stored job.

1. Hold down **Store** while you press the number of the job you want to play back.
2. Play or move the cursor to the point where you want to *begin* deleting text.
3. Hold down **Del** while you press **Find**.
4. Type the text that you want to delete to.
5. Press **End**. The following message appears:

PRESS Del AGAIN TO DELETE OR PRESS ← TO CANCEL

- Press **Del** to delete up to the specified text.
 - Press the **Correction** key to cancel delete.
6. Close storage when you finish revising the job.

Practice

1. Hold down **Store** while you type the number of the job you stored on page 5-8.
2. Press the **Find** key.
3. Type the phrase *and provided*.
4. Press **End** to play to the revision point. Your printed copy should resemble the following:

In the late nineteenth century, a period in history marked by the first years of the industrial revolution and the development of new technologies, typing contests drew enthusiastic spectators

5. Hold down **Del** while you press **Find**.
6. Type the phrase *In those days*.
7. Press **End**.
8. When the message is displayed, press **Del** to delete text up to the phrase. Your display should resemble the following:

enthusiastic spectators In those days, typing speeds
ARTN STORE PLAY

9. Press ← once, then type a period (.), and press the **Spacebar** one time.
10. Press **End** to finish playing back the job, then close the storage area. Your printed copy should resemble the example below:

In the late nineteenth century, a period in history marked by the first years of the industrial revolution and the development of new technologies, typing contests drew enthusiastic spectators. In those days, typing speeds of 40 to 45 words per minute were considered astonishing.

Using Change

The Change function is similar to the Find function. Using the Change function, you can specify text to search for within a job, and new text to replace the text searched for. For example, you can change the word *dog* to *cat*, or change the phrase *dogs chase cats* to *cats chase dogs*. This ability to find and change text in a single operation can save considerable time in the revision process. The Change function works only in No Print.



Changing Text

1. Hold down **Store** while you type the number of the storage area you want to open.
2. Select No Print. The NO PRT indicator is displayed.
3. Press the **Chng** key. The following message is displayed:



4. Type the text that you want to change (up to 24 characters).
 - Type the text *exactly* as it appears in your stored job.
 - When searching for the word *the*, your typewriter will also find and change occurrences of the words *then*, *these*, *lathe*, and so on. Use punctuation, capitalization, or spaces before and after the word to find the text you want.
 - Use the **Correction** key to correct typing errors.
5. Press **→** to move the cursor to the next message:

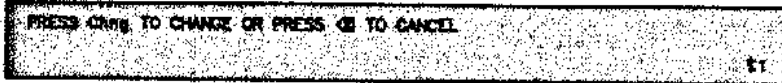

6. Type the new text (up to 24 characters).
 - Type the text *exactly* as it should appear in your stored job.
 - Use the **Correction** key to correct typing errors.
7. Press **End** to search from the current cursor position to the end of the job, or press **Home** to search from the current cursor position to the *beginning* of the job.
 - You can also press **Chng**, **→**, or **↓** to search to the end of the job. **Find** may also be used, but only a Find operation is performed.
8. The typewriter finds the next occurrence of the specified text in the direction you indicated and displays the line of text along with the following message:

9. Press **Chng** to change the text, or press **Correction** to cancel the Change function.

Repeating Change

1. Press **Chng**.
 - The last text you specified is displayed.
2. When the message is displayed, do one of the following:
 - To repeat Change without altering either position, continue with step 3.
 - Type new text over the old text in the first position, then press **→** to move to the second position.
 - Press **→** to move to the second position without altering text in the first position. Type new text over the old text in the second position.
3. Press **End** to search from the current cursor position to the end of the job, or press **Home** to search from the current cursor position to the *beginning* of the job.
 - You can also press **→** or **↓** to search to the end of the job.
4. When the message is displayed, press **Chng** to change the text, or press the **Correction** key to cancel the Change function.

Practice

1. Insert a 12-pitch printwheel, then hold down **Format** while you press **2** to use the format you saved on page 1-25 (LMar 12 RMar 55).
2. Hold down **Store** while you type the number of the job you stored on page 5-11.
3. Select **No Print**.
4. Press the **Chng** key.
5. Type the word *typing*, then press **→** to move to the next position.
6. Type the phrase *typing speed*.
7. Press **End** to search for the *next* occurrence of the text. When the message is displayed, press the **Chng** key to change the text.
8. Press the **Chng** key, then press **→** to move to the second position.
9. Type the phrase *touch typing*.
10. Press **End** to search for the next occurrence of the text. When the message is displayed, press the **Chng** key to change the text.
11. Press the **Chng** key.
12. Type the word *new*, then press **→** to move to the second position.
13. Type the word *advanced*.
14. Press **Home** to search from the current cursor position to the *beginning* of the job. When the message is displayed, press the **Chng** key to change the text.
15. Close storage when you finish changing text.
16. Play back a copy of the job. Your printed copy should resemble the following:

In the late nineteenth century, a period in history marked by the first years of the industrial revolution and the development of advanced technologies, typing speed contests drew enthusiastic spectators. In those days, touch typing speeds of 40 to 45 words per minute were considered astonishing.

Helpful Hints

- If the **TEXT NOT FOUND** message is displayed:
 - Make sure you typed the text *exactly* as it appears in the stored job.
 - Make sure the cursor is not already on the text you want to change.
 - Repeat **Change** and press **End**, then repeat **Change** and press **Home** to make sure you have searched the entire job.
 - Press *any key* to clear the **TEXT NOT FOUND** message from the display.
 - The following message is displayed when text you specify closely resembles text in the job; for example, when the number of spaces typed between words in specified text differs from that in the job.
- CLOSE MATCH FOUND; PRESS CHNG TO CHANGE OR PRESS CLR TO CANCEL
- If you specify more than 24 characters on the **Change** menu, the typewriter beeps and ignores each additional character you type.
 - Many alternate keyboards contain accent marks that are dead keys that print without advancing the carrier to the next space. To find text containing accent marks, type the character but not the accent mark. For example, to find *resumé*, type *resume*.

Form Letters

A form (repetitive) letter is the same letter sent to several different people. When typing a form letter, store the repetitive information (the body of the letter), then play back the letter and type variable information (name, inside address, and so on).

1. Hold down **Store** while you press the number where you want to store the letter.
2. Type the form letter placing stop codes wherever variable information is to appear.
3. Press **Store** to close storage.

In the example below, the variable information, such as name, address, salutation, and additional information in the body of the letter, is shaded (■). When you type the letter, type stop codes where the address, name, and other variable information appear. You can type the shaded information in stop code comments to remind you what information to type in the letter.

Note: Because the stop codes and stop code comments do not print on the paper, your copy may not match the example below when you first type it.

6 CRlms

Code + 9 (■ Inside Address) Code + 9

2 CRlms

Dear Code + 9 (■ Name) Code + 9
Thank you for ordering an IBM Typewriter.
On Code + 9 (■ Date) Code + 9 we will deliver
your new typewriter. Please call me if
you have any questions.

3 CRlms

Cordially yours,

3 CRlms

Paul Boler
Sales Manager

Store

Playing Back a Form Letter

1. Make sure the **STORE** indicator is turned off before beginning playback. If storage is open, variable text will be stored with the form letter.
2. Hold down **Play** while you type the number where the form letter is stored.
3. When playback stops at a stop code, type the variable information.
 - The information you type prints on your playback copy only. Use the **Correction** key to correct errors while typing the variable information.
4. Press **End** to continue playback.
5. Repeat steps 3 and 4 for each additional stop code.
6. Repeat steps 2 through 4 for each additional letter.

Document Assembly

Document Assembly is the process of combining storage areas to reuse text that has already been stored. Combining jobs is a quick way to insert recurring text such as closing paragraphs, addresses, and phrases into current jobs. Documents can be assembled on paper (in Character or Delay Print) or only on the display (in No Print). In No Print, the entire job is copied into an open storage area. In Character or Delay Print, parts of a job can be copied into an open storage area. Copying always starts at the beginning of the job.

Should the assembly require more storage space than is available, the following message is displayed:

INSUFFICIENT TYPEWRITER STORAGE. USE DEL TO DELETE STORAGE AREAS

Important: This typewriter has been designed so that, even if your jobs were stored with *different* margins, they will all play back with the *same* margins during document assembly.

If your jobs were stored with different margins and should be assembled with their stored margins intact, use the Indent function as described in "Changing Margins and Tabs After Opening Storage" on page 3-9 to set temporary margins during document assembly.

If the job you are copying was stored with indented margins, make sure the assembled document plays back correctly.

Assembling Documents in No Print

Use No Print to copy an entire storage area quickly into an existing storage area. You can also use No Print to duplicate a storage area before extensively revising it.

1. Hold down **Store** while you type the number of the storage area where you want to copy the job.
 - If the storage area you have selected already contains text, the **PLAY** indicator is displayed.
2. Select **No Print**.
3. Move the cursor to the point where you want to insert the other job.
4. Hold down **Play** while you press the number of the stored job that you are copying. Release the keys.
 - The printwheel spins when the job is copied.
5. Close storage.

Assembling Documents in Character and Delay Print

Parts of jobs can be combined using Character or Delay Print. If the result is to be saved, open storage before beginning the assembly.

To assemble jobs, print the first job up to the point where the second job should start. Begin playing the second job. If you stop printing before the end of the second job, the **SUSPND** indicator is displayed to remind you that the playback of two jobs has been stopped (suspended). At this point, you have four options:

- Type or correct text.
- Resume playback.
- Cancel playback. Canceling the second job allows you to resume printing the first job.
- Begin playing back a third job. Playing a third job completely cancels printing of the second job. Canceling the third job allows you to resume printing the first job.

Assembling in Character or Delay Print with Storage Open

Follow the steps below to save an assembled document.

1. You may want to make a copy of your job before beginning document assembly.
2. Hold down **Store** while you type the number of the first job that you want to play back.
3. Select **Delay Print** or **Character Print**.
4. Press **End**, **↓**, or **→** to start playback.
5. Press *any key* to stop playback of the first job near the point where you want to copy the other job, then press **→** or **Code + →** to play to that point.
6. Hold down **Play** while you press the number of the second job.
 - The job plays back from the beginning.
7. Press *any key* to stop playback of the second job near the point where you want to copy another job or continue playback of the first job, then press **→** or **Code + →** to play to that point.
 - The SUSPND indicator comes on to remind you that the first and second jobs are suspended.
8. Do one of the following:
 - Press **Play** to cancel playback of the unprinted portion of the second job.
 - The SUSPND indicator is turned off.
 - Press **End**, **→**, or **↓** to continue playing back the second job. When the end of the second job is reached, playback stops and the SUSPND indicator is turned off.
 - Hold down **Play** while you type the number of a third job.
 - The third job plays back from the beginning.
 - The unplayed text of the second job is not included in the document you are assembling.
 - The SUSPND indicator is turned off.
9. Press **End**, **→**, or **↓** to continue playing back the first job.
10. Press **Store** to close the storage area.

Assembling in Character or Delay Print with Storage Closed

Hold down **Play** while you type the number of the first job that you want to play back, then continue with step 5 above. Do not press **Store** to open a storage area. Your assembled document will not be stored.

Practice

1. Insert a 12-pitch printwheel, then hold down **Format** while you press **2** to use the format you saved on page 1-25 (LMar 12 RMar 55).
2. Store the paragraphs below in storage area 80. If storage area 80 already contains text, close the storage area and open another.

This is storage area 80, paragraph 1. After a job is stored, you can combine it with other jobs.

This is storage area 80, paragraph 2. To combine jobs, simply use **PLAY**. When storage is open, the result of the combination will be saved.
3. Store the paragraphs below in storage area 81. If storage area 81 already contains text, close the storage area and open another.

This is storage area 81, paragraph 1. When the playback of two jobs has been stopped, the SUSPND indicator is displayed.

This is storage area 81, paragraph 2. Pressing any key stops playback. When playback is stopped, press **END** to resume playback. Press **PLAY** to cancel playback.
4. Store the paragraphs below in storage area 82. If storage area 82 already contains text, close the storage area and open another.

This is storage area 82, paragraph 1. When you stop playback of a job, you can type or correct text, resume playback, cancel playback, or begin playing a third job.

This is storage area 82, paragraph 2. Press **PLAY** plus a number to begin playing a third job.
5. Complete the exercises on pages 5-22 and 5-23.

Exercise 1: Combining Jobs with Storage Closed

1. Hold down **Play** while you type 80.
2. Press any key to stop playback as soon as printing begins.
3. Use ↓ to play paragraph 1 and the blank line following it. Do not play the first line of paragraph 2.
4. Hold down **Play** while you type 81.
5. Press any key to stop playback as soon as printing begins.
 - The **SUSPND** Indicator is displayed.
6. Use ↓ to play paragraph 1 and the blank line following it. Do not play the first line of paragraph 2.
7. Hold down **Play** while you type 82.
8. Press any key to stop playback as soon as printing begins.
 - The **SUSPND** Indicator is displayed.
9. Use ↓ to play paragraph 1 and the blank line following it. Do not play the first line of paragraph 2.
10. Press **Play** to cancel further playback of storage area 82.
 - The **SUSPND** indicator is turned off.
11. Press **End** to resume playback of storage area 80.

Exercise 2: Combining Jobs into a New Storage Area

1. Open storage area 85. If storage area 85 already contains text, close the storage area and open another.
2. Copy storage area 80 into storage area 85 as follows:
 - a. Select **No Print**.
 - b. Hold down **Play** while you type 80.
3. Press **Home** to move to the beginning of storage area 85.
4. Select **Character Print**.
5. Use ↓ to play paragraph 1 and the blank line following it. Do not play the first line of paragraph 2.
6. Follow steps 4 through 10 of Exercise 1 to play back the first paragraph from storage areas 81 and 82.
7. Press **End** to resume playback of storage area 85.
8. Close the storage area.

Exercise 3: Combining Jobs into an Existing Storage Area

Follow these steps to copy the first paragraph of storage areas 81 and 82 into storage area 80. Since storage area 80 will be altered, you may want to copy storage area 80 into another storage area before doing the exercise (See page 3-14 for more information).

1. Open storage area 80.
2. Use ↓ to play paragraph 1 and the blank line following it. Do not play the first line of paragraph 2.
3. Follow steps 4 through 10 of Exercise 1 to play back the first paragraph from storage areas 81 and 82.
4. Press **End** to resume playback of storage area 80.
5. Close the storage area.

Helpful Hints

- When storing various parts of a job in separate areas, you may want to press **CRtn** twice at the end of each job. This allows one blank line between paragraphs stored separately when they are played back in document assembly.
- You cannot copy a job into itself.
- If the **STORAGE FULL** message appears, delete a job to clear space in storage for the job being copied.
- If the typewriter beeps when you try to copy the job:
 - You may be trying to copy a nonexistent job. Make sure a job is stored.
 - You may be trying to copy a job during **Centering**, **Right Flush**, or **Decimal Tabulation**. Turn these functions off when assembling jobs.
- When jobs are suspended, the printed text can be corrected. If you move the carrier away from the point where you stopped playback, the typewriter will "relocate" to that point before continuing playback.

Using Mark for Preprinted Forms

The Mark function helps you automatically type preprinted forms. Typing forms is a two-step process: first, store a layout of the form using the Mark function; second, play back the form and fill in the blanks.

When storing the form layout, mark the form at each point where text is inserted or needs to print. A mark (**Code + Shift + M**) identifies a point on the form to which the carrier should move.

See the sample form on the next page:

- Each *M* shows where to type a mark. (The *M* does not actually print.) A mark automatically supplies a stop code. During playback the carrier moves to the mark and stops for you to type variable information. *Variable information is text that changes for each form and is not stored with the job.*
- Each *MC* shows where to type a mark. Press the Correction key one time to erase the supplied stop code. After you erase the stop code, type constant information. *Constant information is text that is the same for each form and is stored with the job. The typewriter prints the constant information at these locations (MC) as you type and when you play back the form.*

Sample Preprinted Form

Newspaper Subscription Service

Contributors List

First Name M	M.I. M	Last Name M	Contribution Amt. M
Address M			Date of Contribution M
City M	State M	Zip M	ID Number M
Telephone No. M			

Distribute to: Accounting
Publishing
Direct Mail

MC
Route Manager

MC
Newspaper

Storing a Form Layout

1. Insert a blank form using the **Paper Ball Load Lever**.
2. Set the *left margin* at the *left edge* of the paper.
3. Hold down **Store** while you press the number of the storage area you want to open.
4. Select Character Print. Character Print allows you to move the carrier to the exact typing location on the form.
5. Turn the ARTN indicator off.
6. Type the form layout as follows:
 - a. Move the carrier to the first point on the form where variable or constant information needs to print. Use any of the following keys:
 - Paper movement keys (**Paper Up**, **Paper Down**, **Code + Paper Up**, and **Code + Paper Down**).
 - **CRtn**.
 - **Spacebar**, **Tab**, **Backspace**, or **Code + Backspace**.
 - b. At each point where variable information is to appear, hold down both **Code** and **Shift** while you press **M**.
 - The following symbols are displayed at the mark point. The symbols do not print on your paper.

 - If you want to add a stop code comment at the mark point, hold down **Code** while you press **9**, type the stop code comment, then hold down **Code** while you press **9** again. The stop code you typed replaces the one supplied by the **Mark** function, but does not erase the mark.
 - c. At each point where constant information is to appear, hold down both **Code** and **Shift** while you press **M**. Then press the **Correction** key one time and type the constant information.
 - When you press the **Correction** key, the supplied stop code is erased. During playback, the typewriter will print the constant information without stopping.
7. Repeat step 6 for each mark point until you finish the form.
8. Press **Store** to close storage when you finish typing the form layout.

Helpful Hints

- Marks do not have to be inserted in any particular order. For example, you may move the paper down to a previous line and insert a mark. However, the marks will play back in the order they were entered.
- Mark symbols do not print on your paper.
- Marks cannot be used when the **DEC T**, **CENTER**, or **RFLUSH** indicators are displayed.
- If you forget to type a mark while typing a form layout:
 - Erase back to where the mark should be and type it; or
 - Use paper movement keys to move to the point where the mark should be and enter it; or
 - Complete the form, then revise it. See "Correcting the Form Layout" on page 5-28 for more information.
- If you type a mark by mistake, press **Correction** two times to erase it.

Playing Back the Form Layout

1. Insert a blank form using the **Paper Ball Load Lever**.
2. Set your left margin at the left edge of the paper.
3. Use the **Paper Up**, **Paper Down**, **↓**, or **↑** keys to position the carrier on the first line of the form, then hold down **Code** while you pull the **Paper Ball Load Lever** forward to set a new top margin. Push the **Paper Ball Load Lever** back to the closed position and release the **Code** key.
4. Turn the ARTN indicator off.
5. Make sure the **STORE** indicator is turned off before beginning playback or variable information will be stored with the form.
6. Hold down **Play** while you press the number of the storage area where you stored the layout.
 - The typewriter begins playing back the layout.
7. When the typewriter stops, type the variable text to fill in the form.
 - If you make a mistake, use the **Correction** key to correct it.
8. The typewriter prints the constant information without stopping.
 - If the typewriter stops at the constant information, you did not erase the stop code when you stored the form layout.
9. Press **End** to continue playback.
10. Repeat steps 7 through 9 until you finish playing back the form.

Helpful Hints

- Because you are playing back the format with storage *closed*, the variable information is *not* stored with the form layout.
- The correction memory is cleared each time you type or play a mark.

Correcting the Form Layout

1. Hold down **Store** while you press the number of the storage area where you stored the layout.
 - The **STORE** indicator is displayed.
 - The **PLAY** indicator is displayed.
 - The following symbols are displayed at each mark point:

2. Use **→** to play to the point where you want to add or delete a mark.
 - Hold down both **Code** and **Shift** while you press **M** to add a mark.
 - Press the **Correction** key once to delete only the stop code.
 - Press the **Correction** key twice to delete the stop code and the mark.
3. Close the storage area.

Practice

Make a copy of the sample form on page 5-25, or use a form from your business or home. Follow the steps on pages 5-26 and 5-27 to practice storing and playing back the layout.

Required Page Ends

Multipage jobs can be stored in a single storage area. As you store the job, use the Required Page End function after short pages such as title pages, table of contents pages, and cover letters. You can also use required page ends between the pages of multipage forms.

Typing a Required Page End

Hold down **Code** while you press **E (PgEnd)** at the end of each page.

Playing Back a Job that Contains a Required Page End

During playback, the typewriter stops at the required page end and the **END OF PAGE REACHED** message is displayed.

1. Use the Paper Release Lever to remove paper.
2. Use the Paper Ball Load Lever to insert paper.
3. Once paper is inserted, press **End** to continue playback.

Using Auto Page End and Required Page End

Use Required Page End after short pages. When you play back a job with Auto Page End turned on, pages will end at a required page end. If there is no required page end, pages will end according to the Page-Layout settings. For more information, see "Page-Layout" on page 4-10.

Alternate Keyboards

Read this chapter *only* if you have a printwheel for other languages, ASCII (PC), or Latin Supplemental ISO.

Your typewriter has primary and alternate keyboards. You have already been using your primary keyboard.

- The primary keyboard allows you to type in your own language. Your typewriter automatically sets your primary keyboard to match the keybuttons on your typewriter.
- Alternate keyboards, when used with the appropriate printwheels, allow you to type in other languages such as French and Spanish, or ASCII (PC) and Latin Supplemental ISO.

Matching Printwheels and Keyboards

Each printwheel for alternate keyboards contains characters other than those printed on your typewriter keybuttons. You can access characters of an alternate keyboard by typing a keyboard change called a keyboard identification (ID) number.

The keyboard ID is printed on all printwheels. When more than one set of numbers is shown, the first number is the keyboard ID; for example: 001-008. The keyboard ID for the United States is 001 or 1. Look at the example below.

See the list on page 6-3 for alternate keyboard ID numbers.

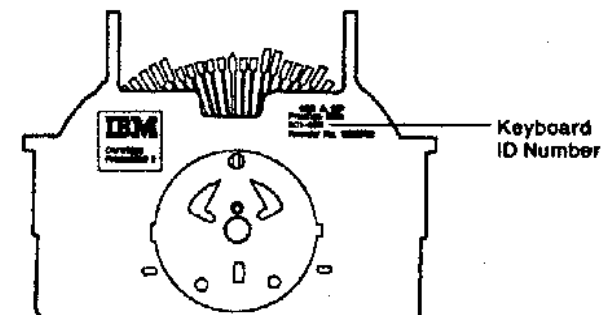

Using Alternate Keyboards

1. Select a keyboard and keyboard ID number for a country or special application from the charts on pages 6-4 through 6-10.
2. Insert the country or special application printwheel.
 - The ID number on the keyboard list should match the number on the printwheel.
3. Hold down **Code** while you press **L (Lang)** and type the keyboard ID; for example: **Code + L + 251**.
 - The KYBD indicator comes on, followed by the keyboard ID you have chosen.
 - The keyboard is changed to the alternate keyboard.
4. Find the keyboard chart that matches your keyboard ID and use it to locate the character you want to type.
5. When you finish typing in the alternate keyboard, hold down **Code** while you press **L (Lang)**.
 - The KYBD indicator goes off.
 - The keyboard returns to the primary keyboard.
6. Remove the country or special application printwheel and install the 001 primary printwheel.

Note: Hold down **Code** while you press **L** to gain access to your secondary keyboard (Latin Supplemental ISO).

Helpful Hints

- Many alternate keyboards contain accent marks that are dead keys that print without advancing the carrier to the next space. To type accent marks over alphabetic characters:
 1. Type the accent mark first.
 - The carrier will not advance to the next space.
 2. Type the alphabetic character.
- The alternate keyboard charts show some keybuttons with special characters. See "Special Characters" on page 2-11.
- The alternate keyboard is saved when you turn the typewriter off.
- The typewriter stops automatically for keyboard changes during playback. Refer to "Playback Rules" on page 3-26 when playing back a job with a keyboard change.

Keyboard Alphabetic Cross-Reference

Keyboard Name	ID Number	Page
ASCII (PC)2	103	6-8
Australia	1	6-4
Austria	29	6-4
Belgium	251	6-10
Brazil	81	6-7
Canada (Bilingual)	39	6-5
Canada (English)	1	6-4
Denmark	59	6-6
Finland	53	6-6
France	251	6-10
Germany (PC)2	249	6-10
Germany (West)	29	6-4
Greece (Greek)	219	6-9
Greece (Latin)	207	6-9
Hong Kong	119	6-8
Italy	41	6-5
Italy (PC)2	247	6-10
Japan (English)	89	6-7
Latin America	25	6-4
Latin Supplemental ISO1	99	6-8
Netherlands	43	6-5
New Zealand	1	6-4
Norway	55	6-6
Portugal	63	6-7
South Africa	81	6-5
Spain	70	6-6
Sweden	53	6-6
Switzerland (French)	49	6-5
Switzerland (German)	51	6-6
Turkey	79	6-6
United Kingdom	67	6-7
United Kingdom (PC)2	252	6-10
United States	1	6-4

1 Special application keyboard chart.

2 Personal computer keyboards charts.

Keyboard Charts

The following keyboard charts show the keyboard ID numbers and the character locations. The charts are arranged numerically.

Keyboard ID 1 — Australia, Canada (English), New Zealand, United States

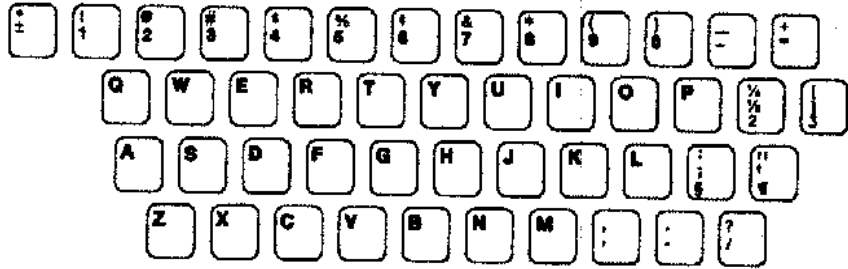

Keyboard ID 25 — Latin America

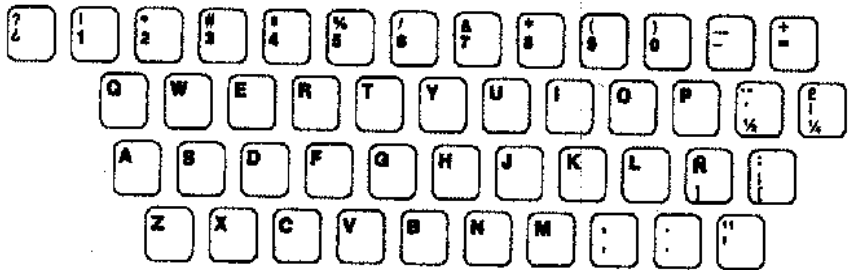

Keyboard ID 29 — Austria, Germany (West)

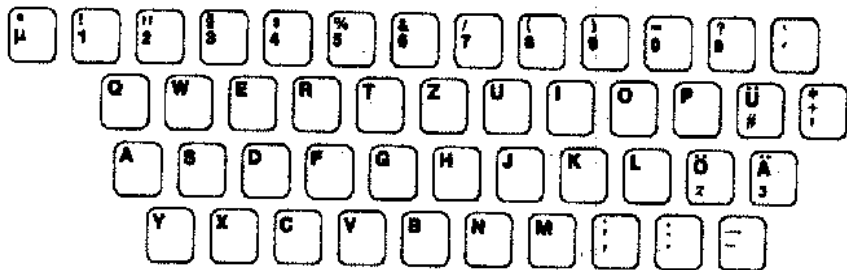

Keyboard ID 39 — Canada (Bilingual)

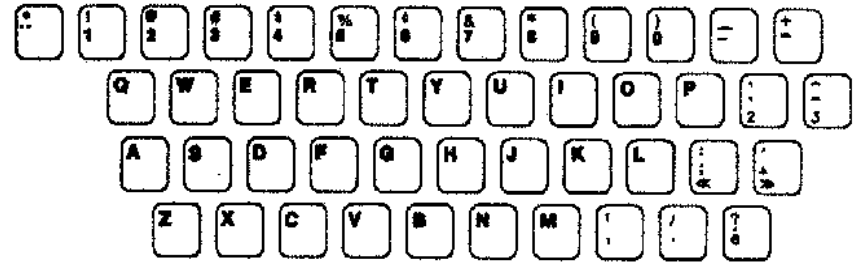

Keyboard ID 41 — Italy

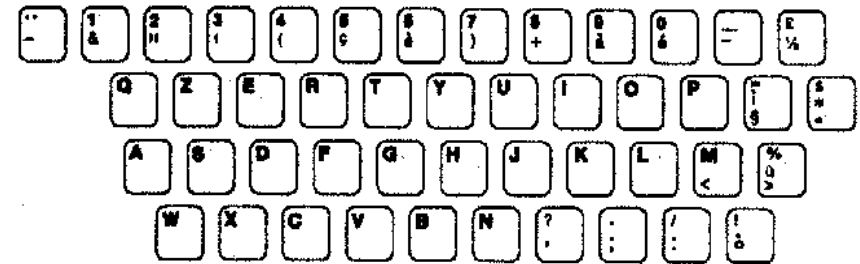

Keyboard ID 43 — Netherlands

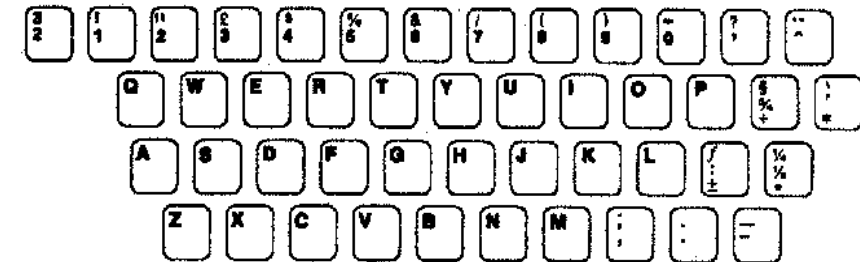

Keyboard ID 49 — Switzerland (French)

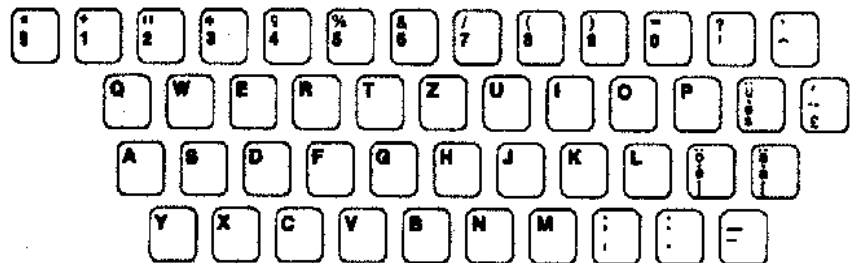

Keyboard ID 51 — Switzerland (German)

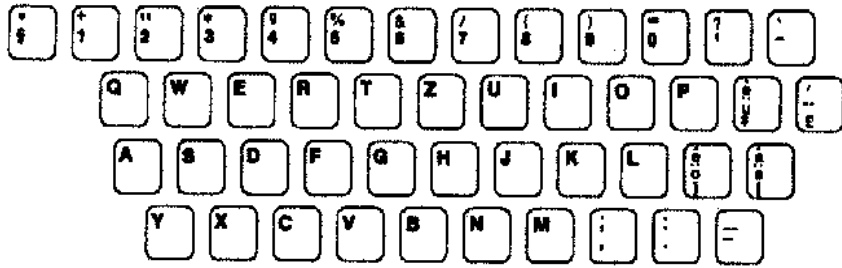

Keyboard ID 53 — Finland, Sweden

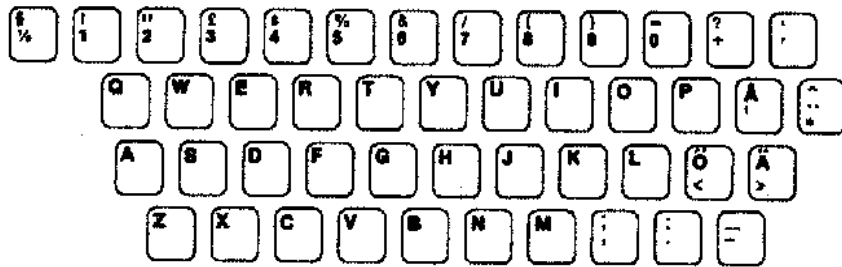

Keyboard ID 55 — Norway

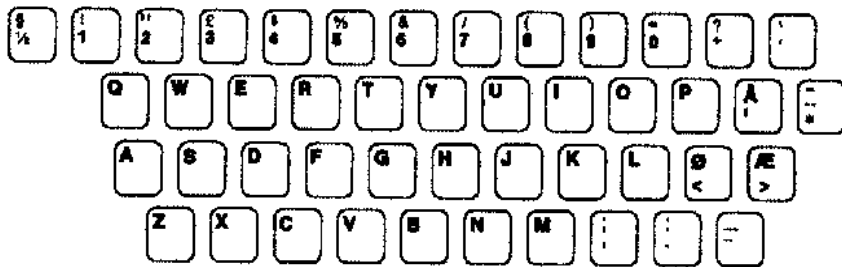

Keyboard ID 59 — Denmark

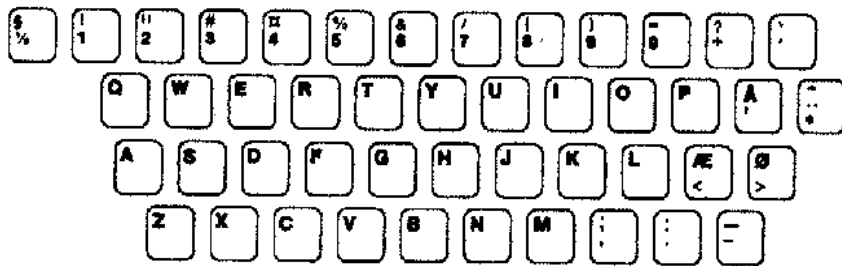

Keyboard ID 61 — Brazil

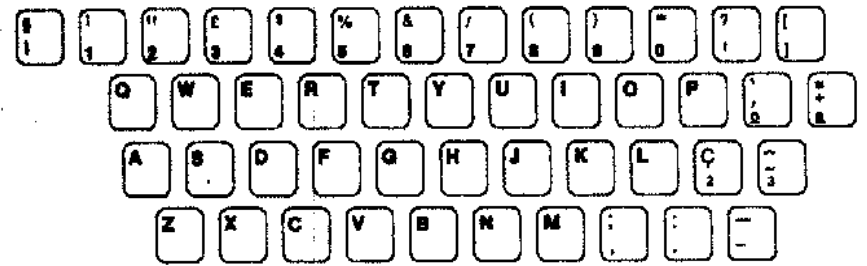

Keyboard ID 63 — Portugal

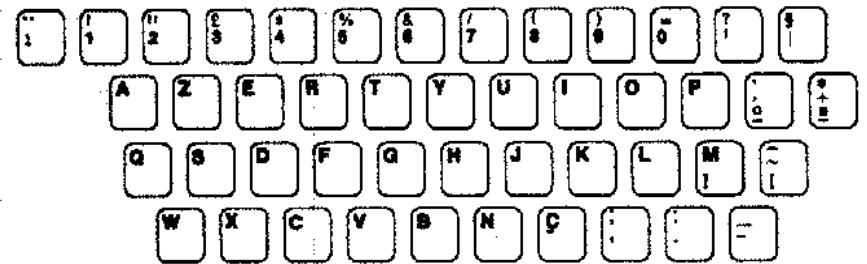

Keyboard ID 67 — United Kingdom

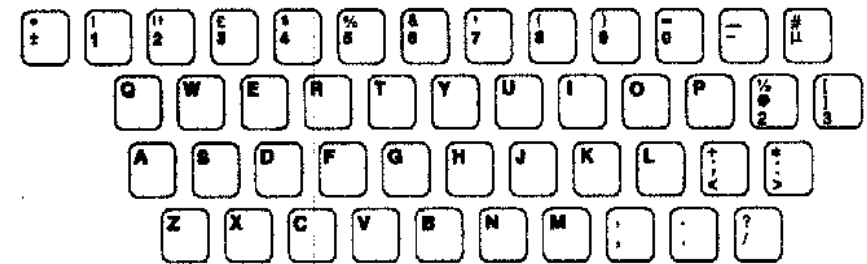

Keyboard ID 69 — Japan (English)

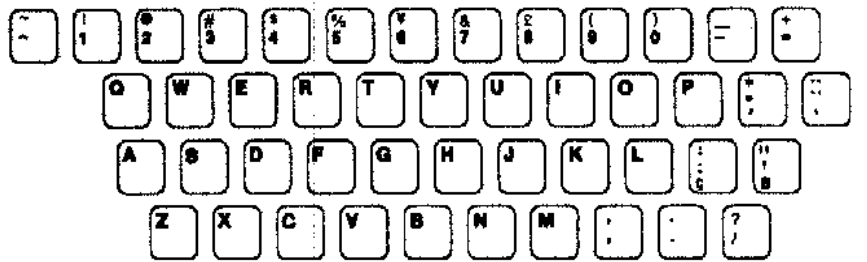

Keyboard ID 70 — Spain

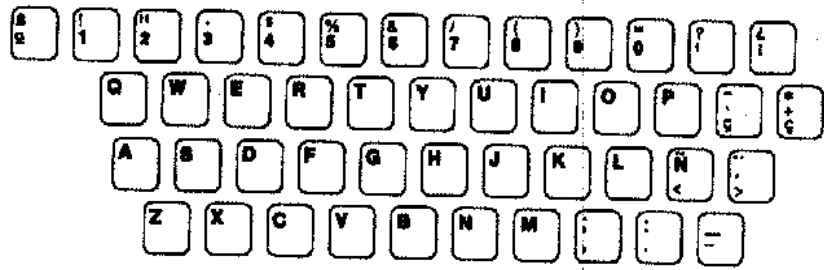

Keyboard ID 79 — Turkey

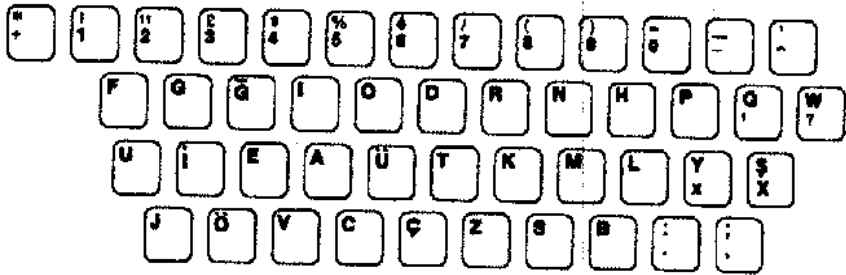

Keyboard ID 81 — South Africa

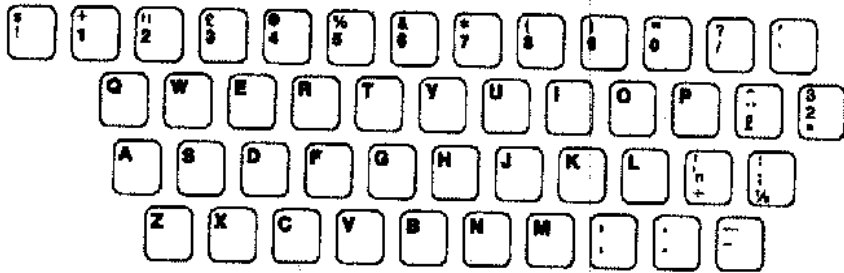

Keyboard ID 99 — Latin Supplemental ISO

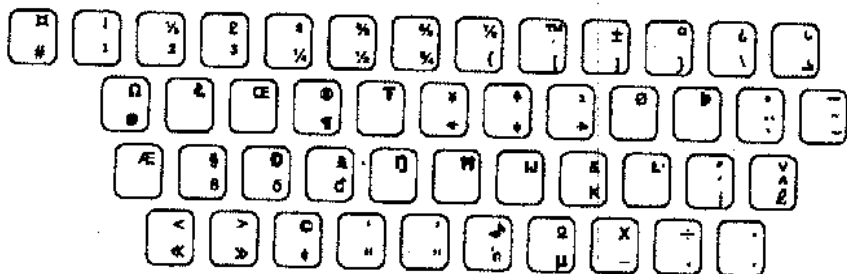

Keyboard ID 103 — ASCII (PC)

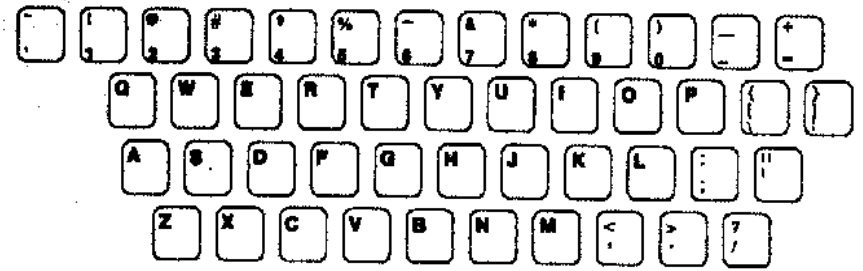

Keyboard ID 119 — Hong Kong

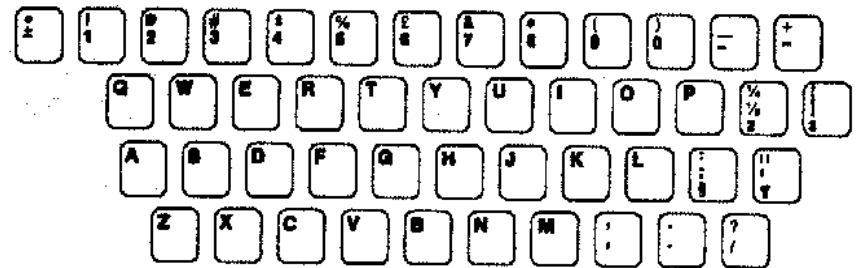

Keyboard ID 207 — Greece (Latin)

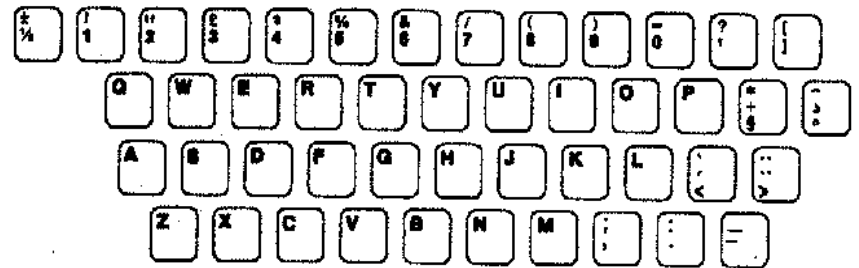

Keyboard ID 219 — Greece (Greek)

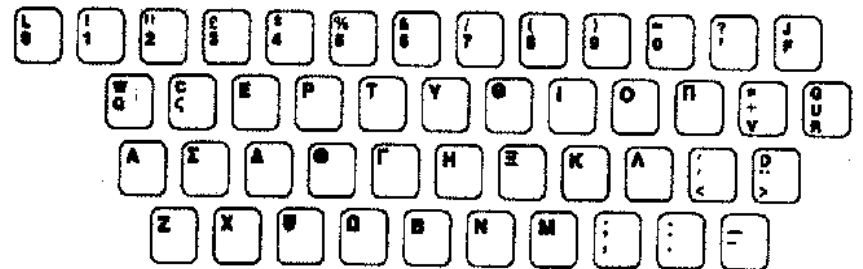

Keyboard ID 247 — Italy (PC)

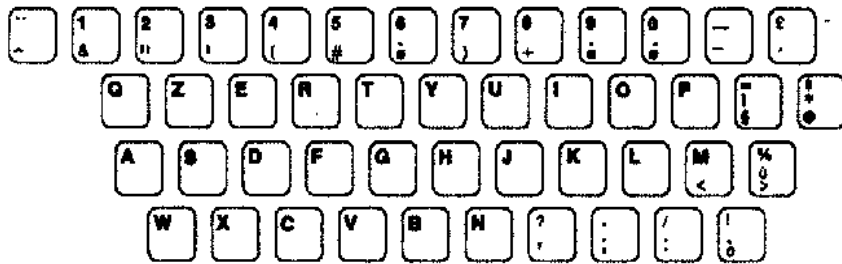

Keyboard ID 249 — Germany (PC)

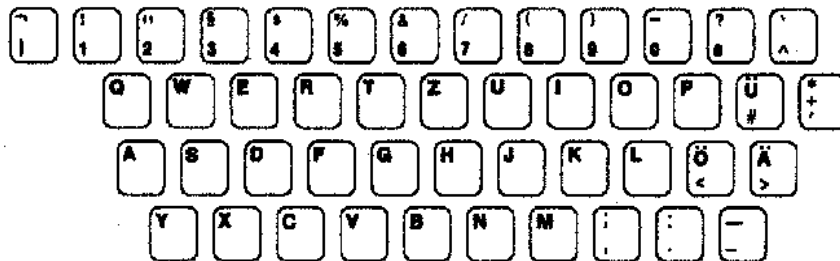

Keyboard ID 251 — Belgium, France

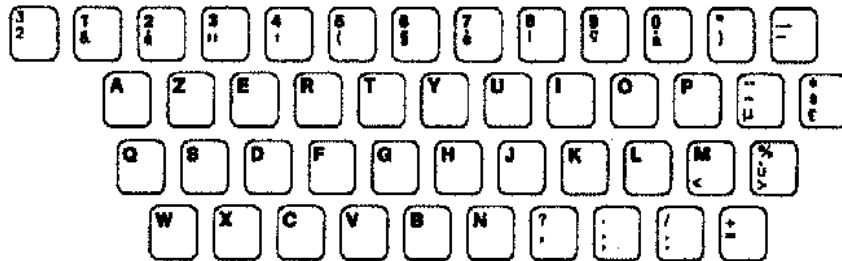

Keyboard ID 252 — United Kingdom (PC)

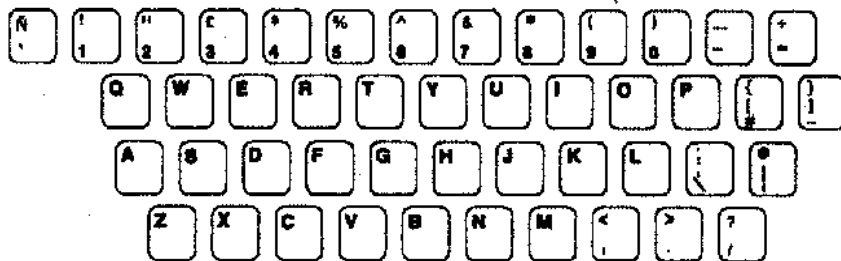

Reference

Use this chapter to learn how to:

- Order IBM supplies for the typewriter.
- Remove and install the ribbon and printwheel in the typewriter.
- Change batteries.
- Take care of your typewriter.

This chapter also contains recommendations for ribbons and printwheels for various applications.

Ordering Procedures for IBM Supplies

To order IBM supplies, contact an IBM Authorized Dealer or call IBM Direct at 1-800-IBM-2468. In Canada, call IBM Direct at 1-800-465-1234.

Typestyle Samples

The IBM Cartridge Printwheel II is designed for use with IBM Wheelwriter® Typewriters and IBM Wheelprinters. The protective cartridge makes installation easy and protects the printwheel from damage. The wide variety of typestyles and sizes allows you to select one for readability, emphasis, or space requirements to make your work look the way you want.

The order number which follows each typestyle name is for the American Standard Character Set. Personal computer, foreign language, and symbol character sets are also available.

- ▲ = 10 pitch
- △ = 12 pitch
- = 15 pitch
- = proportional spacing

Note: Because of the differences between printed and typewritten impressions, the typestyle samples on the following pages should be used only as a guide.

Typestyle Samples and Pitches

10 Pitch

▲ Advocate 1353845	IBM's variety of attractive type
▲ Artisan 10 1353520	IBM's variety of attractive type
▲ Bookface Academic 1353844	IBM's variety of attractive type
▲ Courier 10 1353511	IBM's variety of attractive type
▲ Delegate 1353849	IBM's variety of attractive type
▲ Manifold 1353846	IBM'S VARIETY OF ATTRACTIVE TYPE
▲ OCR-A 1353248	IBM's variety of attractive type
▲ OCR-B 1353247	IBM's variety of attractive type
▲ Pica 1353829	IBM's variety of attractive type
▲ Presentor 1353015	IBM's variety of attractive type
▲ Prestige Pica 1353503	IBM's variety of attractive type
▲ P&P #3 OCR 1353054	IBM's variety of attractive type
▲ Rhetoric 1353738	IBM'S VARIETY OF ATTRACTIVE TYPE
▲ 1403 OCR 1353075	IBM'S VARIETY OF ATTRACTIVE TYPE

12 Pitch

△ Adjutant 1353047	IBM's variety of attractive typestyles suit
△ Artisan 12 1353060	IBM's variety of attractive typestyles suit
△ Auto Elite 1353080	IBM's variety of attractive typestyles suit
△ Courier 12 1353523	IBM's variety of attractive typestyles suit
△ Courier 12 Italic 1353890	IBM's variety of attractive typestyles suit
△ Dual Gothic 1353055	IBM's variety of attractive typestyles suit

12 Pitch (continued)

△ Elite 1353881	IBM's variety of attractive typestyles suit
△ Large Elite 1353017	IBM's variety of attractive typestyles suit
△ Letter Gothic 1353514	IBM's variety of attractive typestyles suit
△ Light Italic 1353764	IBM's variety of attractive typestyles suit
△ Olde World 1353875	IBM's variety of attractive typestyles suit
△ Prestige Elite 1353502	IBM's variety of attractive typestyles suit
△ Scribe 1353982	IBM's variety of attractive typestyles suit
△ Script 1353778	IBM's variety of attractive typestyles suit

15 Pitch

■ Courier 15 1353798	IBM's variety of attractive typestyles suit many
■ Gothic 15 1353718	IBM's variety of attractive typestyles suit many
■ Prestige 15 1353655	IBM's variety of attractive typestyles suit many

Proportional Spacing

● Boldface * 1353504	IBM's variety of attractive typestyles suit
● Boldface Italic * 1353059	IBM's variety of attractive typestyles suit
● Essay * 1353526	IBM's variety of attractive typestyles suit
● Essay Italic * 1353130	IBM's variety of attractive typestyles suit
● Modern * 1353517	IBM's variety of attractive typestyles suit
● Thesis * 1353953	IBM's variety of attractive typestyles suit
● Title * 1353952	IBM's variety of attractive typestyles suit

* For use on typewriters and printers with proportional spacing.

Printwheel Application Recommendations

Typestyle	1-3 Carbon Copies	3-5 Carbon Copies	Stencils	Bold Print
10 Pitch:				
Advocate	A	A	A	C
Artisan 10	A	A	A	A
Bookface Academic	B	C	B	A
Courier 10	A	A	B	A
Delegate	A	A	B	B
Manifold	A	A	B	A
Pica	A	A	A	C
Prestige Pica	A	B	B	A
Rhetoric	B	C	B	A
Rhetoric Presentor	B	C	B	A
Symbol 10	B	C	C	B
12 Pitch:				
Adjutant	A	A	B	B
Artisan 12	A	A	B	A
Auto Elite	A	A	A	A
Courier 12	A	A	B	A
Courier 12 Italic	A	A	B	A
Dual Gothic	A	B	B	C
Elite	A	A	A	C
Large Elite	A	A	A	C
Letter Gothic	A	A	B	A
Light Italic	A	A	A	B
Olde World	A	C	NR	A
Prestige Elite	A	B	A	A
Scribe	A	A	A	B
Script	B	C	C	A
Symbol 12	C	C	C	B

Ratings:

A - Good; B - Fair; C - Marginal; NR - Not Recommended
(Based on proper selection of ribbon, carbon paper, and stencils)

Typestyle	1-3 Carbon Copies	3-5 Carbon Copies	Stencils	Bold Print
15 Pitch:				
Courier 15	A	B	B	A
Gothic 15	B	C	B	A
Prestige 15	A	B	A	C
Symbol 15	C	C	C	B
PS Pitch:				
Boldface	B	C	B	A
Boldface Italic	B	C	B	A
Essay	A	B	B	A
Essay Italic	A	B	B	A
Modern	A	B	B	A
Thesis	A	B	B	A
Title	A	B	B	A

Ratings:

A - Good; B - Fair; C - Marginal
(Based on proper selection of ribbon, carbon paper, and stencils)

Note: There are 3 symbol printwheels: Symbol 10, Symbol 12, and Symbol 15. For best results, use a symbol printwheel that matches the pitch of your regular printwheel. For example, use Symbol 15 with 15-pitch typestyles.

Removing the Printwheel

CAUTION

To prevent unwanted carrier motion, make sure the paper ball is against the platen.

1. Pull the print hammer all the way toward you and hold it.
2. While you are holding the print hammer, grasp the printwheel tab.
3. Lift the printwheel straight up and out of the slot. Be careful not to scratch the ribbon.
4. Release the print hammer.

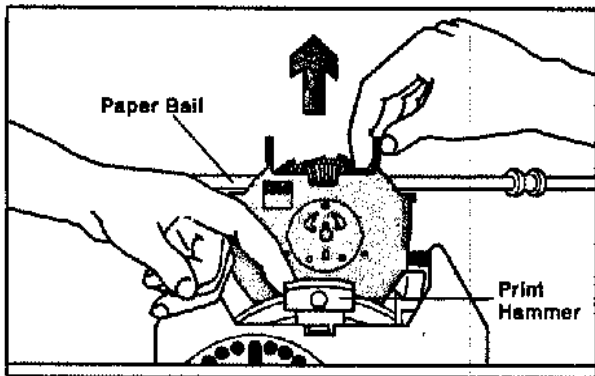
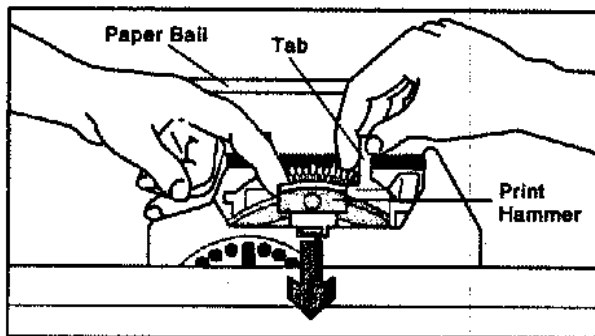

Installing the Printwheel

Important: Remove the yellow shipping seal from the center of a new printwheel before you install it.

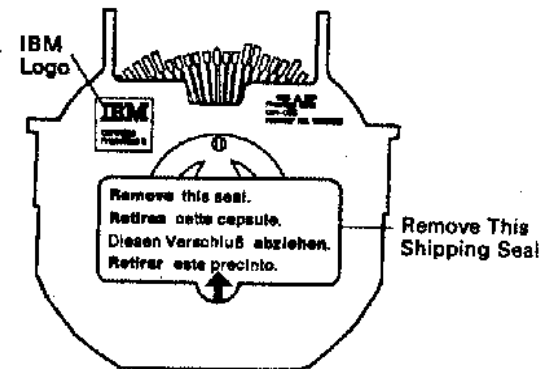

CAUTION

To prevent unwanted carrier motion, make sure the paper ball is against the platen.

1. Hold the printwheel so the letters IBM are in the upper left corner.
2. Pull the print hammer all the way toward you and hold it.
3. While you are holding the print hammer, lower the printwheel into the slot. Be careful not to scratch the ribbon.
4. After the printwheel touches the bottom of the slot, release the print hammer.
5. Press the Code key.
 - The printwheel spins.

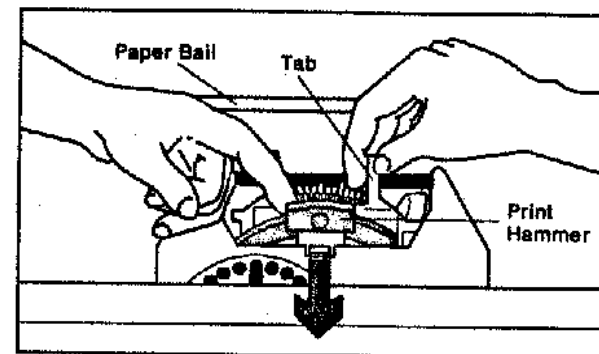

Ribbon Cassette System

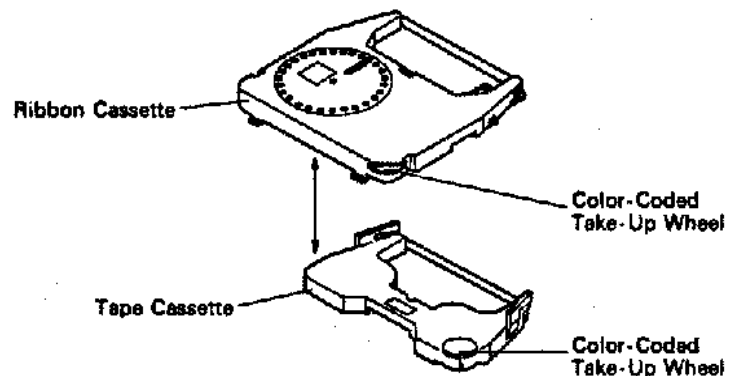

The ribbon and tape cassettes fasten together. Each type of ribbon and tape cassette has a color-coded take-up wheel. In most cases, the wheel color helps you match the ribbon to the correction tape. (See "Ribbon Cassette Reorder Numbers" on page 7-11.) The color also tells you which type of ribbon you are using.

Removing the Cassettes

1. Space or tab to the center of your typewriter.
2. Raise the typewriter cover.
3. Make sure the paper ball is against the platen.
4. Push the release lever until the cassettes release.
5. Lift the cassettes up and out of the typewriter.

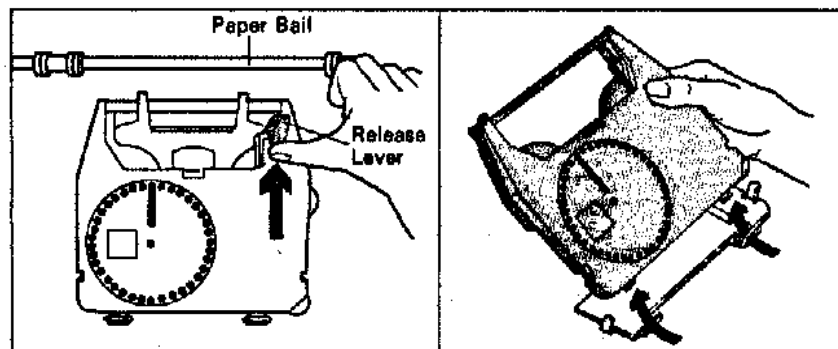

Installing the Cassettes

1. After you remove the cassettes from your typewriter, press on the top of the center latch, slide the cassettes apart and throw away the used cassette.
2. Slide the ribbon cassette onto the tape cassette.
 - Be sure the center latch latches onto the correction tape.
3. Press the gray tabs (on both ends of the correction tape) to be sure the tape and ribbon cassettes are latched together.
4. Before installing the ribbon in the typewriter, tighten any slack in the ribbon by turning the take-up wheels to move the color-coded leaders past the center.
5. Install the cassettes in your typewriter.
6. Push down on the upper right corner of the ribbon cassette to snap it into place.

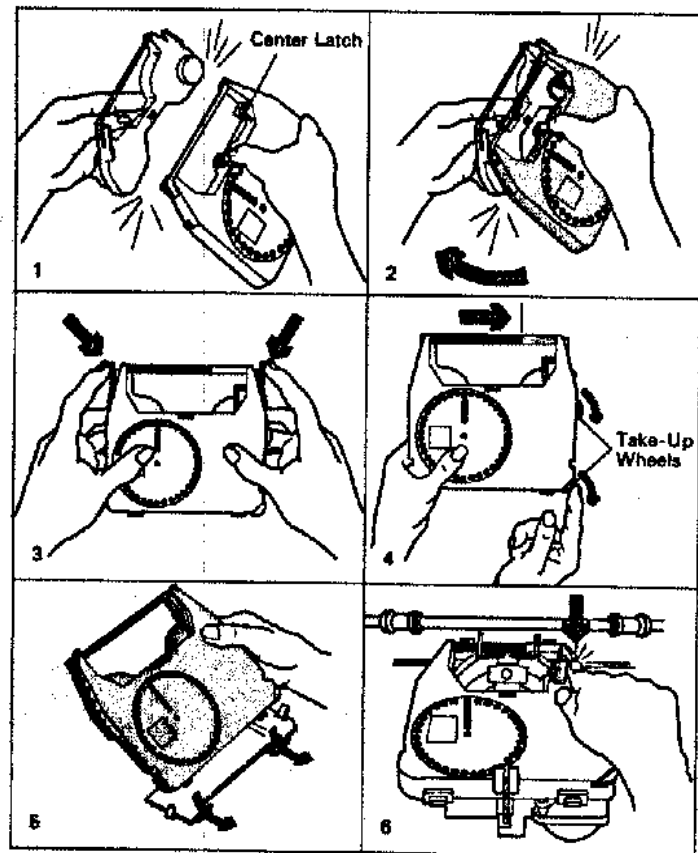

Ribbon Application Recommendations

Typing Applications	Multi-purpose Ribbon Cassette	High Yield Correctable Ribbon Cassette	Fabric Ribbon Cassette	Superior Write Correctable Ribbon Cassette
Legal Correspondence	●	●	NR	●
Executive Correspondence	●	●	NR	●
General Correspondence	●	●	●	●
Hard-to-Image Originals ¹	●	NR	●	●
OCR	●	NR	NR	NR
Speech Writing ²	●	NR	●	●
Negotiable Instruments – (checks, stocks, and so on)	●	NR	●	NR
Erasable Bond ¹	●	NR	NR	●
Quality of Original				
1 - 3 Carbons	Good	Good	Good	Good
3 - 5 Carbons	Fair	Marginal	Fair	Fair

● = Recommended

NR = Not Recommended

¹ The receptivity of the surface of these materials varies widely, and care must be used in the selection of a specific material to be typed on, typestyle, impression control, and ribbon to produce the best result. The IBM Easystrike® Superior Write Correctable Ribbon is recommended for most hard-to-image applications. However, there are some specially coated or treated surfaces where the multipurpose ribbon must be used. When in doubt, prepare samples first.

² Best results with Rhetoric and other large typestyle printwheels are obtained by using the IBM Easystrike® Multipurpose Ribbon.

Ribbon Cassette Reorder Numbers

Use the table below to find the reorder number for the matching cassettes you need.

Ribbon	Take-Up Wheel Color	Correction Tape	Take-Up Wheel Color
IBM Easystrike® High Yield Correctable Ribbon Cassette ³ Reorder Number: 1299846 (black only)	Orange	IBM Easystrike® Lift-Off Tape Cassette Reorder Number: 1337785	Orange
IBM Easystrike® Correctable Ribbon Cassette Reorder Numbers: 1337781 (black) 1337782 (brown) 1337783 (blue)	Orange	IBM Easystrike® Lift-Off Tape Cassette Reorder Number: 1337785	Orange
IBM Easystrike® Superior Write Correctable Ribbon Cassette ⁴ Reorder Number: 1380999 (black only)	Purple	IBM Easystrike® Lift-Off Tape Cassette Reorder Number: 1337766	Orange
IBM Easystrike® Multi-purpose Ribbon Cassette Reorder Number: 1337764 (black only)	Blue	IBM Easystrike® Cover-Up Tape Cassette Reorder Number: 1337766	Blue
IBM Easystrike® Fabric Ribbon Cassette Reorder Number: 1356000 (black only)	Red	None	None

³ Long-life correctable film ribbon; recommended for general correspondence.

⁴ Recommended for bold and dark print, especially on difficult-to-image papers.

Batteries

Important: Do not turn the typewriter off while replacing batteries. If you do, margins and stored jobs will be lost.

Your typewriter uses three size AA alkaline batteries. These batteries are used to save stored jobs, margins, tabs, and other settings when the typewriter is turned off. They must be installed correctly and changed at least once every year (before they run down).

The following settings are saved when you turn the typewriter off if you have properly charged batteries installed:

- Top Margin
- Active Format Area
- Line Space Setting
- Automatic Carrier Return On or Off
- Hyphenation On or Off
- Justification On or Off
- Active Keyboard
- Active Print Mode
- Auto Page End On or Off
- Tab Adjust On or Off
- Keyboard Clicker On or Off
- Page-Layout Settings

When changing the batteries, use only size AA alkaline batteries (for example, Duracell⁵ type MN 1500, Eveready⁶ type E91, Ray-O-Vac⁷ type 815, or equivalent). Do not use rechargeable batteries.

⁵ Trademark of Duracell, Inc.

⁶ Trademark of the Union Carbide Corp.

⁷ Trademark of the Ray-O-Vac Corp.

Checking the Batteries

If the beeper signals three times and the LO-BAT indicator is displayed when you turn the typewriter on, check the following while the typewriter is on:

1. Look at the batteries for correct installation.
2. If the batteries are installed correctly, the batteries may be weak or dead.
3. Replace all three weak or dead batteries.
4. Do not turn the typewriter off while replacing the old batteries. If you turn the typewriter off without batteries installed, margins and stored jobs will be lost. (See page 7-15 for correct installation.)

Removing Old Batteries

Warning: Do not turn the typewriter off while replacing the old batteries. If you turn the typewriter off without batteries installed, margins and stored jobs will be lost.

1. Make sure the typewriter is turned on.
2. Raise the typewriter cover.
3. Locate the black plastic battery holder on the right front side of the typewriter.
4. Remove the holder by putting your finger under it and pushing up. Then carefully pull the holder out as far as it can go.
5. Push the batteries against the spring ends of the holder and pop them out.

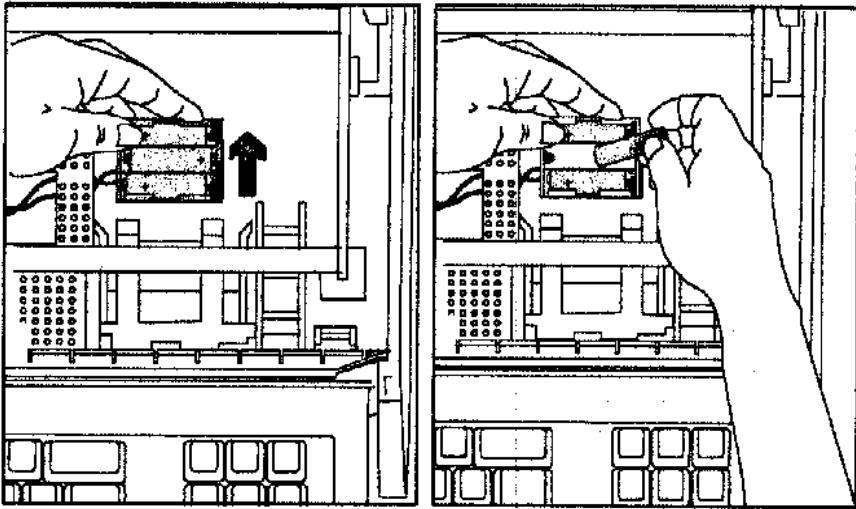

Installing New Batteries

1. Install three (3) new batteries in the holder by placing the flat end of the batteries against the springs.
 - Make sure the plus (+) signs on the batteries match the plus signs inside the holder.
2. Place the battery holder back into the typewriter.

Note: The batteries will *not* save margins, stored jobs, and other settings unless the plus sign on each battery matches the plus sign inside the holder.

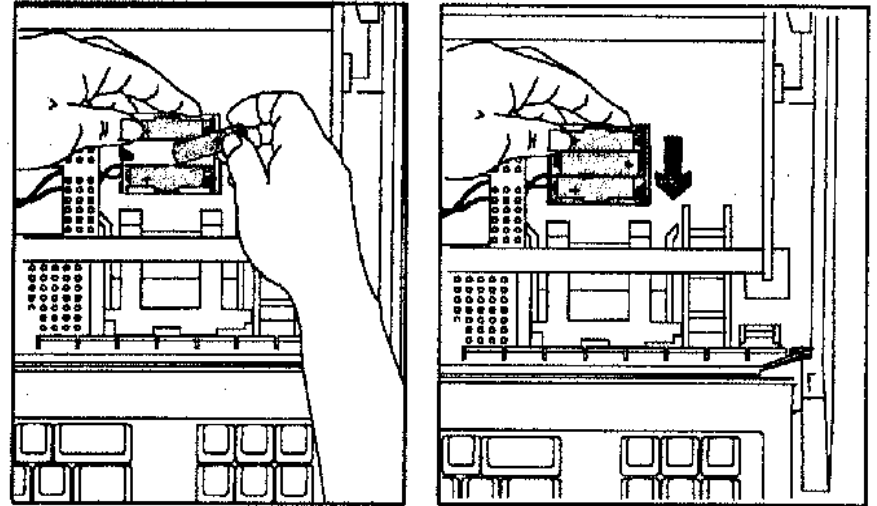

Care and Maintenance

Cleaning the Typewriter Cover

Important: Use only a damp cloth and mild detergent to clean the typewriter cover and keybuttons. Certain cleaning fluids may be harmful. *Do not use IBM cleaning fluid.*

Serial Number

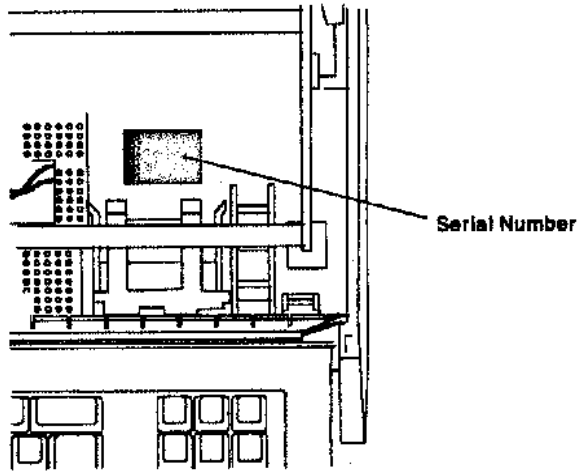

To locate the serial number on your typewriter, raise the typewriter cover and look on the right of the inside bottom cover. The serial number (S/N) is shown on the voltage label behind the batteries.

Problem Determination

How to Use This Chapter

This chapter describes problems or questions you may have while using your typewriter. If a problem occurs while using the typewriter, refer to this chapter for help. You may be able to correct the problem yourself, saving service costs and avoiding unnecessary downtime.

Before you call for service:

1. Find the problem in the following index.
2. Turn to the page referenced.
3. Complete as many steps as needed to correct the problem. Do not attempt any disassembly beyond the instructions given. For assistance, call your IBM Authorized Dealer.

Problem Determination Index

Typewriter Problems	8-3
Display Problems	8-3
Erase Problems	8-3
Correction Key Does Not Erase All of the Character or Correction Leaves Shadows	8-3
Printwheel Spins Instead of Erasing	8-3
Keyboard Problems	8-4
Keyboard Locked, Display Blank	8-4
No Clicking Sound	8-4
Paper Problems	8-4
Paper Not Loading	8-4
Print Quality Problems	8-4
Characters Do Not Print	8-4
Characters Print Too Lightly	8-5
Characters Unclear	8-5
Typing Problems	8-5
Typewriter Operates Hot	8-5
Typewriter Too Noisy	8-5
Line Spacing Aligns Incorrectly	8-6
Paper Feeds Incorrectly	8-6
Wrong Characters Print or Characters Space Incorrectly	8-6
Carrier Stops Before Reaching Left Margin	8-7
Spelling Function Problems	8-7
Spelling Function Does Not Work	8-7
Diskette Option Problems	8-7
Diskette Functions Do Not Work	8-7
Messages and Error Codes with Beep Signals	8-8
Messages and Indicators without Beep Signals	8-10
Display Symbols	8-15
Display Indicators	8-16
Typewriter Messages	8-17
Spelling Function Messages	8-18
Diskette Option Messages	8-18

Typewriter Problems

Display Problems

1. Turn the contrast knob on the side of the display.
2. Tilt the display to adjust it to the lighting conditions in the room.
See page 1-4 if you need help.
3. Make sure the display connections are not loose.
4. If the display is attached correctly, turn the typewriter off. Wait 30 seconds, then turn the typewriter on again.

Erase Problems

Correction Key Does Not Erase All of the Character or Correction Leaves Shadows

1. Make sure the ribbon and correction tape cassettes are fastened together correctly.
 - Make sure the center latch is latched securely. (See "Installing the Cassettes" on page 7-9.)
 - Make sure the gray tabs are pressed in.
2. Make sure the correction tape matches the ribbon. Make sure the ribbon and correction tape cassettes are installed in the typewriter correctly.
3. Try a lighter impression setting.
4. Try a new correction tape and type any character to reset the correction system.
5. Try plain bond paper.
6. Look for folds in the paper.
7. Make sure the typewriter is on a level surface.
8. Make sure you are using the same printwheel for both typing and erasing.
9. Make sure the Bold function is on if you are erasing bold characters.

Printwheel Spins Instead of Erasing

The character is outside the correction memory and must be erased manually. See "Erasing Manually in 10, 12, and 15 Pitch" on page 1-29.

Keyboard Problems

Keyboard Locked, Display Blank

1. Turn the typewriter off.
2. Wait at least 30 seconds, then turn the typewriter back on.

No Clicking Sound

The keyboard clicker may be turned off.

1. Hold down Code while you press S.
2. Try typing and listen for the clicker.

Paper Problems

Paper Not Loading

1. Make sure the paper release lever is pushed all the way back.
2. Make sure a printwheel is installed.

Print Quality Problems

Characters Do Not Print

1. Make sure you are using the correct pitch or language.
2. Make sure the ribbon is installed correctly.
3. Make sure the printwheel is installed correctly.
 - Look at the printwheel for broken parts.
4. Try a new ribbon.
5. Make sure the platen is latched down at both ends.
 - Pull the paper release lever all the way toward you.
 - Push down firmly on each end of the platen. Then push the paper release lever all the way back.
6. Try a new printwheel.

Characters Print Too Lightly

1. Make sure the ribbon is installed correctly.
2. Look for folds in the ribbon.
3. Change the impression control. See "Impression Control" on page 1-15 for more information.
4. Look for folds in the paper.
5. Try a new ribbon.
6. Try plain bond paper.
7. Try a new printwheel.

Characters Unclear

1. If excess ink particles from the ribbon appear on the paper, try a lower impression control setting.
2. Try a new printwheel.
3. Try a new ribbon.

Typing Problems

Typewriter Operates Hot

1. Make sure nothing is blocking the top, rear, or bottom typewriter vents.
2. Make sure the typewriter is at least 75 mm (3 in) from the wall on all sides.
3. Make sure the typewriter is not near a heater.

Typewriter Too Noisy

1. Make sure the cover and soundhood, if you have a soundhood, are closed tightly.
2. Move any objects touching the typewriter cover.
3. Look for objects in the typewriter.
4. Remove any material placed under the typewriter.
5. Check the typing table or desk. Metal tables can make the typewriter sound noisy.

Line Spacing Aligns Incorrectly

1. Look for objects inside the typewriter.
2. Look at the number of carbon copies being used (five maximum).
3. Make sure the paper release lever is pushed all the way back.

Paper Feeds Incorrectly

1. Check the number of carbon copies being used (five maximum).
2. When inserting loose carbon copies, pull the paper release lever forward; insert the copies; then push the lever all the way back.
3. Look for labels or paper caught under the platen.
4. Make sure the paper release lever is pushed all the way back.
5. Make sure the platen is latched down at both ends.
 - Pull the paper release lever all the way toward you.
 - Push down firmly on each end of the platen. Then push the paper release lever all the way back.
6. If you change the paper ball load lever setting at any time, make sure it is checked before feeding paper. See "Changing the Top Margin" on page 2-22.

Wrong Characters Print or Characters Space Incorrectly

1. Turn the typewriter off, wait 30 seconds, then turn the typewriter on again and try typing again.
2. Make sure the LANG indicator is off.
3. Try a new printwheel.
4. Look for objects in the path of the carrier.
5. Make sure the printwheel is changed when there is a language change.
6. If you are playing back, make sure you use the same pitch printwheel you used when you typed the text.

Carrier Stops Before Reaching Left Margin

The carrier probably caught on something when returning to the left margin.

1. Turn the typewriter off.
2. Look for objects in the path of the carrier.
3. Remove the object from the typewriter.
4. Turn the typewriter back on.

Spelling Function Problems

Spelling Function Does Not Work

If the Spelling function does not work, it might be caused by one of the following:

- The function is off.
- Another function is active on the typewriter which prevents the Spelling function from being used (for example, the Printer Option).
- You did not end the word with a word ending (space, punctuation, and so on).
- You are trying to add a word that is already in one of the dictionaries.
- You are trying to delete a word from the *main* dictionary.

Diskette Option Problems

Diskette Functions Do Not Work

1. Turn the typewriter off, wait 30 seconds, then turn the typewriter on again.
2. Try the diskette operation again.
3. If errors continue, make sure the diskette has been prepared.
4. Try a different diskette that has been prepared.

Messages and Error Codes with Beep Signals

If your typewriter fails to operate properly, an error code or message may be displayed. The typewriter beeps several times when an error code appears. The following table lists error codes and messages and tells you what to do when they appear.

Error Code	Condition	Action
END OF RIBBON, 3 beeps	End of ribbon	(Sensor-equipped machines only.) <ol style="list-style-type: none"> 1. Remove the ribbon and install a new one. (See Chapter 6 for help.) 2. Resume typing or playback. 3. If the message recurs, check that the ribbon is good and that it is properly installed. 4. Resume typing or playback. 5. If the message recurs, call your authorized service representative.
LO BAT, 3 beeps	Low batteries	<ol style="list-style-type: none"> 1. Make sure the batteries are not corroded. 2. Make sure the batteries are installed correctly. 3. Replace the batteries. For instructions, see Chapter 6. <p>Note: You should replace batteries as quickly as possible. If the batteries run down and you turn the typewriter off, everything stored is erased.</p>
STORAGE CLEARED, LO-BAT, 3 beeps	Storage cleared; bad batteries	<ol style="list-style-type: none"> 1. Replace the batteries. 2. Turn the typewriter off. 3. Wait 30 seconds, then turn the typewriter on again. 4. If the errors recur, call your authorized service representative.
OUT OF PAPER, 3 beeps	Out of paper	(Sensor-equipped machines only.) Insert a new sheet of paper, then continue typing.
011, 6 beeps	Storage altered	Jobs stored may have been altered. <ol style="list-style-type: none"> 1. Press any key. ● The STORAGE CLEARED message is displayed. 2. Type one line of text into a storage area. 3. Turn the typewriter off. 4. Wait 30 seconds, then turn the typewriter on again. 5. If the error recurs, or stored text was cleared, call your authorized service representative.

Error Code	Condition	Action
Spelling beep sounded three times when you turned the typewriter on	Supplemental dictionary error	The supplemental dictionary has been erased from memory. If you selected a spelling beep tone, it has been reset to the default value and must be selected again.
101, 6 beeps	Program error	Contact your authorized service representative.
121, 6 beeps	Unsupported keyboard	The keyboard that you are using is not supported by your typewriter, or the keyboard is defective. <ol style="list-style-type: none"> 1. Make sure you are using the primary keyboard. 2. Turn the typewriter off. 3. Wait 30 seconds, then turn the typewriter on. 4. If the error recurs, call your authorized service representative.
140, 6 beeps	Spelling function error	Contact your authorized service representative.
160, 6 beeps	Diskette option error	Contact your authorized service representative.
161, 6 beeps	Diskette drive improperly connected to typewriter	<ol style="list-style-type: none"> 1. Check the connection between the diskette drive and the typewriter. Make sure the cable is securely attached. 2. Turn the typewriter off. Wait 30 seconds, then turn the typewriter on again. 3. If the error recurs, contact your authorized service representative.
162, 6 beeps	Diskette option error	Contact your authorized service representative.
215, 6 beeps	Printwheel not installed prop- erly	<ol style="list-style-type: none"> 1. Turn the typewriter off. 2. Make sure the printwheel was installed correctly. 3. Turn the typewriter back on. 4. If the error recurs, contact your authorized service representative.
All other codes, 6 beeps	Various	<ol style="list-style-type: none"> 1. Turn your typewriter off. Wait 30 seconds, then turn your typewriter on. 2. If the error recurs, call your authorized service representative.

Messages and Indicators without Beep Signals

Indicators may blink or appear with other symptoms to signal a particular condition. Indicators displayed in reverse lettering (white letters on black background) usually mean that the typewriter is waiting for you to take action.

Message	Condition	Action
BUSY	The typewriter is processing an instruction you gave it. For example, BUSY appears while the typewriter finds text.	<ul style="list-style-type: none"> Do not type while BUSY is on. Do not turn the typewriter off while BUSY is on.
DISKETTE BUSY	A diskette operation is in progress. For example, DISKETTE BUSY appears while a job is copied to typewriter storage from the diskette. The message goes off when the operation is complete.	<ul style="list-style-type: none"> Do not remove the diskette from the drive while the DISKETTE BUSY message is displayed. Do not turn the typewriter off while the DISKETTE BUSY message is displayed.
DISKETTE ERROR; REQUESTED FUNCTION NOT PERFORMED	An error occurred while reading from or storing on the diskette. The diskette may not have been prepared, the diskette may have been damaged, or the selected job may contain invalid data.	<ul style="list-style-type: none"> Try the same operation again; or Insert a different diskette and repeat the operation.
DISKETTE NOT USABLE; INSERT NEW DISKETTE AND PRESS CR OR PRESS ⏏ TO CANCEL	This message appears only during the PREPARE operation. Required information could not be placed on the diskette, or the diskette was removed before PREPARE was completed. The diskette must be a 3.5 inch 1MB diskette. Using the wrong type of diskette will cause this error.	<ul style="list-style-type: none"> If the diskette was not removed, try a new diskette. If the diskette was removed, put it back in the diskette drive and repeat the PREPARE operation.
DISKETTE PREPARATION COMPLETE	Diskette preparation was properly completed.	Press any key to clear the message from the display.

Message	Condition	Action
DISKETTE TEXT WILL BE LOST; PRESS CR TO CONTINUE OR PRESS ⏏ TO CANCEL	You have attempted to prepare a used diskette. The diskette may have jobs stored on it or may only have been prepared.	<p>To check the contents of the diskette:</p> <ol style="list-style-type: none"> Press the Correction key. Press the Menu key. Select DISKETTE. Select DIRECTORY to view the diskette directory and see what jobs are stored on the diskette. <p>If you want to prepare the diskette anyway, press Correction, then repeat the Prepare operation. Any jobs stored on the diskette are erased as the diskette is prepared.</p>
DISKETTE WAS EXCHANGED; PRESS CR TO CONTINUE OR PRESS ⏏ TO CANCEL	A different diskette was placed in the diskette drive since diskette revision or playback was started.	<p>If the message relates to playback, place the correct diskette in the diskette drive and press CR to continue or press the Correction key to cancel playback.</p> <p>If the job is being stored on the diskette, press CR to proceed with storing the job. Press the Correction key to return to revision.</p> <p>Note: If the typewriter is turned off with a diskette job open for revision, it is stored on the diskette when the typewriter is turned on again.</p>
DISKETTE WRITE-PROTECTED; REQUESTED FUNCTION NOT PERFORMED	The write-protect tab on the diskette is open.	<ol style="list-style-type: none"> Do one of the following: <ul style="list-style-type: none"> Close the write-protect window; or Insert an unprotected diskette. Try the operation again. <p>Note: To quit the job without storing revisions on diskette, see page B-14.</p>
"FROM" STORAGE DOES NOT EXIST; USE ANOTHER STORAGE NUMBER OR PRESS ⏏ TO CANCEL	This message is displayed only during the COPY function. The specified "FROM" number cannot be found.	<p>Do one of the following:</p> <ul style="list-style-type: none"> Specify an existing document; or Press the Correction key to cancel the COPY function.
HYPHEN (Reverse Lettering)	You are playing back a job with HYPHEN on. The typewriter stopped playback and is waiting for you to make a hyphenation decision.	See "Hyphenation during Playback" on page 5-3 for information.













Message	Condition	Action
INSERT DISKETTE AND PRESS CRtn TO CONTINUE OR PRESS ⌘ TO CANCEL	You have selected a diskette function and no diskette is in the drive.	Insert the proper diskette and press CRtn to perform the operation, or press the Correction key to cancel the operation.
INSERT DISKETTE AND PRESS CRtn TO CONTINUE, ⌘ TO CANCEL OR Del TO DELETE	You are trying to store a job on diskette and no diskette is in the drive.	Do one of the following: <ul style="list-style-type: none"> ● Insert the proper diskette and press CRtn to store the job on the diskette. ● Press the Correction key to return to revision. ● Press Del twice to end the job without storing revisions. <p>Note: If the typewriter is turned off with a diskette job open, it is stored on the diskette when the typewriter is turned on again.</p>
INSERT DISKETTE AND PRESS CRtn TO PREPARE OR PRESS ⌘ TO CANCEL	You have selected the diskette prepare function.	Insert the diskette you want to prepare in the diskette drive and press CRtn. If you do not want to prepare the diskette, press the Correction key.
INSERT SCRATCH DISKETTE AND PRESS CRtn TO CONTINUE OR PRESS ⌘ TO CANCEL	You have selected a function intended for the use of service personnel.	Press the Correction key to cancel the operation. Do not press CRtn; this may result in the loss of jobs stored on the diskette.
INSUFFICIENT DISKETTE STORAGE; USE Del TO DELETE STORAGE AREAS	There is not enough storage space on the diskette to hold the job you are trying to store.	Do one of the following: <ul style="list-style-type: none"> ● Use another diskette; or ● Use the delete function to make additional room on the diskette.

Message	Condition	Action
INSUFFICIENT TYPEWRITER STORAGE; USE Del TO DELETE STORAGE AREAS	There is not enough storage space in the typewriter to hold the job you are trying to revise.	Delete typewriter storage areas to free enough storage space to revise the job. Note: You can copy the typewriter storage areas to a diskette before you delete them from typewriter storage.
SPELL (Reverse Lettering)	The Spelling function dictionary does not support an alternate language keyboard; Or The Spelling function is on, but is not checking for misspelled words. You are using another typewriter function that makes the Spelling function inactive temporarily. For example, you may be printing a stored job.	Hold down Code while you press L (Lang). Turn off the second function, and the Spelling function will again be active.
STORE (Reverse Lettering)	Storage is almost full.	See "Storage Full Warning" on page 4-8.
"TO" STORAGE ALREADY EXISTS; USE ANOTHER STORAGE NUMBER OR PRESS ⌘ TO CANCEL	This message is displayed only during the Copy function. The specified "TO" number already exists.	Do one of the following: <ul style="list-style-type: none"> ● Use a new "TO" number that does not already exist; or ● Delete the "TO" number and try the Copy function again; or ● Press the Correction key to cancel the Copy function.
USE IndL OR PRESS LMar AGAIN TO RESET DOCUMENT MARGIN OR ⌘ TO CANCEL	This message is displayed when you press LMar while storage is open.	Do one of the following: <ul style="list-style-type: none"> ● Set a temporary left margin as instructed on page 2-12; or ● Press LMar to change the left margin for the entire job; or ● Press the Correction key to cancel the message.
USE IndR OR PRESS RMar AGAIN TO RESET DOCUMENT MARGIN OR ⌘ TO CANCEL	This message is displayed when you press RMar while storage is open.	Do one of the following: <ul style="list-style-type: none"> ● Set a temporary right margin as instructed on page 2-12; or ● Press RMar to change the right margin for the entire job; or ● Press the Correction key to cancel the message.

Message	Condition	Action
WHEEL (Reverse Lettering)	<ul style="list-style-type: none"> ● You are attempting to type without a printwheel installed in the typewriter; or ● You were playing a job or using Delay Print, Centering, Decimal Tabulation, or Right Flush. The incorrect pitch printwheel is currently installed; or ● An alternate keyboard is going to be selected. 	<ol style="list-style-type: none"> 1. Install the printwheel pitch indicated by the numbers following the WHEEL indicator. 2. Resume typing or playback. <p>Or</p> <ol style="list-style-type: none"> 1. If you need to print a character from an alternate keyboard, make sure the proper printwheel is installed. 2. Press End.
= ?? ????????	Information from different equipment is stored on the diskette.	In order to gain access to the information, you must use the diskette with the equipment on which it was entered.

Display Symbols

The following symbols may appear during normal operation of the typewriter.

Symbol	Meaning
	Bold. This symbol is displayed above each character typed using Bold.
	Centering. This symbol is displayed at the beginning and end of centered text.
	Decimal Tab (Begin). This symbol shows where the decimal tab text begins.
	Decimal Tab (End). This symbol shows where the decimal tab text ends.
	Indent Clear. This symbol is displayed when you hold down Code while you press CRIn to end indenting. The symbol is displayed <i>only</i> when revising a stored job.
	Indent Left. This symbol is displayed when you hold down Code while you press Tab to set a temporary left margin.
	Indent Right. This symbol is displayed when you hold down Code while you press RMar to set a temporary right margin.
	Line Space. This symbol is displayed next to the current line space setting (1, 1½, 2, or 3).
	Mark. These symbols are displayed when you hold down both Code and Shift while you press M to mark a form layout. These symbols are displayed <i>only</i> when revising a stored job.
	Pitch Change. This symbol is displayed when you resume typing after changing pitch.
	Required Carrier Return. This symbol shows a carrier return that always plays back. For example, if you press CRIn before the right margin, the carrier return is required. The typewriter always plays back that carrier return at that point in the job. If several symbols are displayed together and/or a symbol is displayed at the beginning of a line, one blank line will play back for each symbol.
	Required Page End. This symbol is displayed when you hold down Code while you press E to end a page of a multipage job. This symbol is displayed <i>only</i> when revising a stored job.
	Right Flush. This symbol shows you where right flush text begins and ends.

Symbol	Meaning
↓	Subscript. This symbol is displayed when you hold down Code while you press H to type a subscript.
↑	Superscript. This symbol is displayed when you hold down Code while you press Y to type a superscript.
⓪	Stop Code. This symbol is displayed before and after a stop code comment. If you did not type a stop code comment, two symbols appear to show the position of the stop code.
--> <--	Stop Code. During playback, these symbols are displayed when playback stops for a stop code and you have not typed a stop code comment. If you typed a stop code comment, it is displayed between the symbols.
†	Tab. This symbol is displayed when you press Tab.

Display Indicators

Display	Description	Page
ARTN	Automatic Carrier Return on	2-1
APAGE	Auto Page End on	4-13
BOLD	Bold Print on	2-11
BUSY	Typewriter Busy	1-3, 8-10
CAPS	Caps on	1-17
CENTER	Centering on	2-5
CONT	Continuous Underline on	2-4
DEC T	Decimal Tab on	2-14
DL PRT	Delay Print Mode on	2-17
HYPHEN	Hyphenation on	2-1, 5-4
IMPR n	Impression Level (1, 2, or 3)	1-15
JSTIFY	Justification on	2-18
1, 1 1/2, 2, 3	Line Spacing	1-9
KYBD nnn	Keyboard (number)	8-2
LO-BAT	Low Battery	8-8
NO PRT	No Print Mode on	2-17
PLAY	Play	3-6
RFLUSH	Right Flush on	2-7
SHIFT	Shift	1-17
SPELL	Spell Verification on	A-3
STORE	Storage open	3-2
SUSPND	Suspended Playback	5-20
T ADJ	Tab Adjust on	4-17
WHEEL nn	Install Wheel (number)	2-21, 3-26

Typewriter Messages

Message	Page
CLOSE MATCH FOUND; PRESS CHng TO CHANGE OR PRESS ⓪ TO CANCEL	5-15
END OF PAGE REACHED	4-13
END OF RIBBON (sensor-equipped machines only)	5-8
INSUFFICIENT TYPEWRITER STORAGE; USE Del TO DELETE STORAGE AREAS	5-18
OUT OF PAPER (sensor-equipped machines only)	5-8
PAGE LENGTH: nn BOTTOM MARGIN: nn PRESS CRtn TO SELECT OR PRESS ⓪ TO CANCEL	4-10
PRESS CHng TO CHANGE OR PRESS ⓪ TO CANCEL	5-13
PRESS Del AGAIN TO DELETE ALL STORAGE AREAS OR PRESS ⓪ TO CANCEL	3-28
PRESS Del AGAIN TO DELETE OR PRESS ⓪ TO CANCEL	3-17
PRESS Del AGAIN TO DELETE STORAGE nn OR PRESS ⓪ TO CANCEL	3-28
PRESS End TO CONTINUE OR PRESS ⓪ TO CANCEL	4-8
STORAGE CLEARED	1-3 3-28
STORAGE EMPTY	4-3
STORAGE FULL	4-8
TEXT NOT FOUND	5-8 5-15
TYPE OLD TEXT: TYPE NEW TEXT:	5-12
TYPE STOP CODE COMMENT:	3-29
TYPE STORAGE NUMBER:	5-2
TYPE TEXT TO FIND:	5-7
USE InL OR PRESS LMar AGAIN TO REBET DOCUMENT MARGIN OR ⓪ TO CANCEL	3-9
USE InR OR PRESS RMar AGAIN TO REBET DOCUMENT MARGIN OR ⓪ TO CANCEL	3-9
USE ←→ TO POSITION AND PRESS CRtn TO SELECT OR PRESS ⓪ TO CANCEL PAGE-LAYOUT ALTO PAGE END; ON OFF TAB ADJUST; ON OFF	4-10 4-18
USE ←→ TO POSITION AND PRESS CRtn TO SELECT OR PRESS ⓪ TO CANCEL DIRECTORY LIST PAGE-FORMAT SPELL	4-2
USE ↑ ↓ TO POSITION AND PRESS Store, Play OR Del KEY	4-3

Spelling Function Messages

Message	Page
NO WORD AVAILABLE	A-7
OPERATOR ACTION REQUIRED	A-8
SUPPLEMENTAL DICTIONARY EMPTY	A-6
USE ← ↑ ↓ → TO POSITION, CODE +3 TO DELETE WORD FROM SUPPLEMENTAL DICTIONARY	A-5
WORD SPELLED CORRECTLY	A-7

Diskette Option Messages

Message	Page
COPY "FROM" STORAGE NUMBER: "TO" STORAGE NUMBER:	B-18
DISKETTE BUSY	B-10
DISKETTE ERROR; REQUESTED FUNCTION NOT PERFORMED	B-10
DISKETTE NOT USABLE; INSERT NEW DISKETTE AND PRESS CRtn OR PRESS ⏏ TO CANCEL	B-10
DISKETTE PREPARATION COMPLETE	B-10
DISKETTE TEXT WILL BE LOST; PRESS CRtn TO CONTINUE OR PRESS ⏏ TO CANCEL	B-11
DISKETTE WAS EXCHANGED; PRESS CRtn TO CONTINUE OR PRESS ⏏ TO CANCEL	B-11
DISKETTE WRITE-PROTECTED; REQUESTED FUNCTION NOT PERFORMED	B-11
"FROM" STORAGE DOES NOT EXIST; USE ANOTHER STORAGE NUMBER OR PRESS ⏏ TO CANCEL	B-11
INSERT DISKETTE AND PRESS CRtn TO CONTINUE, ⏏ TO CANCEL, OR Dnl TO DELETE	B-14
INSERT DISKETTE AND PRESS CRtn TO CONTINUE OR PRESS ⏏ TO CANCEL	B-12
INSERT DISKETTE AND PRESS CRtn TO PREPARE OR PRESS ⏏ TO CANCEL	B-12
INSERT SCRATCH DISKETTE AND PRESS CRtn TO CONTINUE OR PRESS ⏏ TO CANCEL	B-12
INSUFFICIENT DISKETTE STORAGE; USE Dnl TO DELETE STORAGE AREAS	B-12
"TO" STORAGE AREA ALREADY EXISTS; USE ANOTHER STORAGE NUMBER OR PRESS ⏏ TO CANCEL	B-13
TYPE DISKETTE TITLE:	B-9
USE ← → TO POSITION AND PRESS CRtn TO SELECT OR PRESS ⏏ TO CANCEL DIRECTORY LIST TITLE PREPARE	B-8
- ?? ????????	B-14, B-15

Appendix A. Spell Check II

Spell Check II allows you to check the spelling of words as you type. In addition, you can choose an alternate word for one you have typed. After you type a word, the spelling is checked against a main dictionary and a supplemental dictionary. The main dictionary contains approximately 120,000 words. The supplemental dictionary can contain up to 300 words.

You must *end the word* before it can be checked. The end of a word is recognized, and the word is checked when you type a space or other word ending after the word.

When you type a word that does not match a word in either dictionary, you will hear a beep. This beep, called the spelling beep, has a different tone from the normal typewriter beep. Only words of 23 characters or fewer are checked. The Spelling function beeps to indicate an error when a word with more than 23 characters is typed. Some correctly spelled words may cause a spelling beep because they are not in either dictionary; for example, proper names, abbreviations, and technical terms. You will learn how to create a supplemental dictionary so that these words are not treated as spelling errors.

Capitalization is checked in both the main and supplemental dictionaries. If the word *Ingerman* is in the dictionary, typing the word *ingerman* causes Spell Check II to beep. Compound words, such as *mother-in-law*, are checked as one word.

Spell Check II allows you to ask for assistance with a word. Both the main and supplemental dictionaries are searched for similarly spelled words. A line of up to six words is displayed so that you may choose one to replace the word you typed.

Use the \pm , 1, 2, 3, and 4 keys with the Code key to activate the various functions of Spell Check II. The words labeled above the keys are printed in green to show that these keys are used with the Code key.

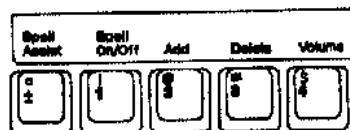

Using Spell Check II

You can use your typewriter with the Spelling function on or off. The Spelling function setting is saved when you turn the typewriter off as long as the typewriter batteries are good. In other words, if the function is off when you turn the typewriter off, it will be off when you turn the typewriter back on.

To turn the Spelling function on, hold down Code while you press 1. The spelling beep sounds and the SPELL indicator is displayed.

To turn the Spelling function off, hold down Code while you press 1. The printwheel spins and the SPELL indicator goes off.

If you type a word not found in either the main or supplemental dictionary, the spelling beep sounds. You can:

- Ignore the beep and continue typing.
- Correct the misspelled word.
- Decide that the word is not misspelled and should be added to the supplemental dictionary. (You will learn about this choice in "Adding a Word to the Supplemental Dictionary" on page A-4.)
- Ask for assistance with the word. See "Spell Assist" on page A-7.

Supplemental Dictionary

The supplemental dictionary is a dictionary you create for your own needs. It contains special words that you use often which are not found in the main dictionary; for example, proper names or technical terms. The contents of the supplemental dictionary are saved when the typewriter is turned off as long as you have good batteries installed in the typewriter.

Unlike the main dictionary, the supplemental dictionary can only check a word *exactly* as you typed it. The word is not checked for plurals, prefixes, or suffixes. For example, if you add the word *frog* to the supplemental dictionary, *frogs* will still cause the spelling beep to sound as if it were a misspelled word.

Each time you add a word to the supplemental dictionary or type a word already in the supplemental dictionary, that word becomes the first word in the dictionary. All other words move back one place. Therefore, the words that are used most often are in the front of the dictionary. The Spell Check II supplemental dictionary can hold up to 300 words or 3,000 characters, whichever is less. When the dictionary is full and you add a word, the last word in the dictionary is deleted.

Adding a Word to the Supplemental Dictionary

If the last word you typed or moved over caused the spelling beep to sound and it is 23 characters or fewer, you can add it to your supplemental dictionary. Remember, you must end the word with a space or punctuation (or move over the word ending) before adding it to the supplemental dictionary.

If you are moving through a job, the last word checked can be added to the supplemental dictionary if the spelling beep sounded after the word. The cursor will be to the right of and not on that word.

Hold down **Code** while you press **2** to add the last word you typed or moved over to the supplemental dictionary. The printwheel spins when the word is added.

Deleting Words from the Supplemental Dictionary

If you accidentally add a misspelled word to the supplemental dictionary, you can delete it. You must end the word with a space, punctuation, or other word ending before you can delete it.

Hold down **Code** while you press **3** to delete the last word you typed or moved over from the supplemental dictionary. The printwheel spins when the word is deleted.

Viewing and Deleting Words from the Supplemental Dictionary

In Spell Check II, you can view the words in the supplemental dictionary on the display and then delete them. The words are displayed in the order they are stored in the dictionary.

1. Press the **Menu** key. A list of functions is displayed.
2. Select **SPELL**. The following message is displayed along with the first word(s) in the supplemental dictionary.

USE ←, ↑, ↓, → TO POSITION CURSOR TO DELETE WORD FROM SUPPLEMENTAL DICTIONARY

3. Use the ←, ↑, ↓, and → keys to view the words in the supplemental dictionary.
 - Five asterisks (*****) indicate the end of the list of words in the supplemental dictionary.
4. To delete a word, move the cursor to the word to be deleted. Hold down **Code** while you press **3**. The printwheel spins when the word is deleted.
5. Press the **Correction** key to resume normal typing.

Note: You can press the **Home** key to view the first words in the supplemental dictionary or press **End** to view the last words. The **SUPPLEMENTAL DICTIONARY EMPTY** message is displayed if there are no words in the supplemental dictionary when **SPELL** is selected.

Checking All Words in a Job

In addition to checking the spelling of words as you type, you can check the spelling of a job that is already stored. This is called batch spell check.

1. Make sure the SPELL indicator is on.
2. Hold down **Store** while you press the number where the job is stored. The **Store** indicator comes on.
3. Select **No Print**.
4. Press **Play** to turn the PLAY indicator on.
5. Press **End**.
 - The display goes blank and the BUSY indicator blinks while the job is being checked.
6. If a misspelled word occurs, the spelling beep sounds and the text is displayed. You can do one of the following and then press **End** to continue:
 - Ignore the misspelled word.
 - Correct the misspelled word by using the **Correction** key.
 - Hold down **Code** while you press **2** to add the word to the supplemental dictionary.
 - Ask for assistance if Spell Check II is installed. (See "Spell Assist" on page A-7.)
7. Repeat steps 5 and 6 until the job is checked.

Spell Assist

Spell Check II allows you to ask for assistance when you type a word that causes the spelling beep to sound. However, the spelling beep does not have to sound before you can ask for assistance with a word. Any time you want to choose an alternate spelling (not a synonym) for a word, you can use Spell Assist. When you ask for assistance, both the main and supplemental dictionaries are searched for words similar to the one you typed. If there are similar words in either dictionary, they are displayed.

Notes:

1. The Spelling function does not have to be on to use Spell Assist.
2. Press the **Correction** key to cancel Spell Assist at any time.

Using Spell Assist

1. Use the **Spacebar**, **←**, or **→** to move the cursor to the word or immediately to the right of the word with which you want assistance.
2. Hold down **Code** while you press **±**.
 - The BUSY message is displayed to let you know that the dictionaries are being searched for alternate words. Then one of the following is displayed:
 - The **NO WORD AVAILABLE** message indicates that there is not an alternate word available. Press any key to continue.
 - The **WORD SPELLED CORRECTLY** message indicates that the word matches one already in the main or supplemental dictionary. Press any key to continue.
 - A list of alternate words, similar to the one you typed, from both the main and supplemental dictionaries is displayed if the word is spelled incorrectly or is not in one of the dictionaries.

3. To choose one of the alternate words, move the cursor to the word and press **CRtn**.



Julia brushes her out diary
diary diary diary diary diary diary

- If the incorrect word can be automatically replaced, it is erased on the paper and on the display. The new word appears on the display as it is typed on the paper.
 - If the **OPERATOR ACTION REQUIRED** message is displayed, followed by the word you chose, you will have to correct the word yourself. Make a note of the word so you can correct it later. Press any key to continue.
4. If you do not choose one of the alternate words, you can press the **Correction** key to cancel Spell Assist.

Changing the Sound of the Spelling Beep

You may want to change the sound of the spelling beep to a tone that is different from the typewriter next to you, or to a volume that is more suitable to the level of noise in your work area.

Hold down **Code** while you press and release **4** until the spelling beep has the sound you desire. There are several choices. The tone you selected is saved when you turn the typewriter off as long as the typewriter batteries are good.

Appendix B. Diskette Option

The Diskette Option gives the typewriter virtually unlimited storage space. Each diskette will hold approximately 720,000 bytes (about 240 to 360 pages) in up to 99 storage areas. Since diskettes are removable, storage capacity is limited only by the number of diskettes you have. You can use a diskette to hold several large jobs, to store confidential information, or to group jobs by their type (such as Mr. Smith's letters, wills, or forms). Use a diskette to store jobs that must be kept for a long period of time so that typewriter storage is available for current jobs. Jobs on a diskette are saved even when batteries run down. Contact your IBM Authorized Dealer to purchase a Diskette Option for your typewriter.

Using the Diskette Option

All of the functions of the typewriter are available when using the Diskette Option. When a diskette job is being revised, the entire job is copied into typewriter storage. For this reason, store most jobs on diskette to ensure that typewriter storage is available for revising large diskette jobs. Revisions to diskette jobs are saved on the diskette after you close diskette storage. There is even a way to disregard the latest changes when you do not want to save them.

Diskette Functions

Choosing **DISKETTE** from the Menu enables you to select from several diskette functions. You can view or list the diskette directory, view or change the diskette title, or prepare a new diskette for use.

The Copy function allows you to copy jobs wherever they are needed. You can copy any diskette job to diskette or to typewriter storage, or you can copy a job from typewriter storage to another storage area or to a diskette.

Before you use this section, read the first five chapters of this book. Review the sections explaining typewriter storage, playing back and revising stored jobs, and using the Menu function.

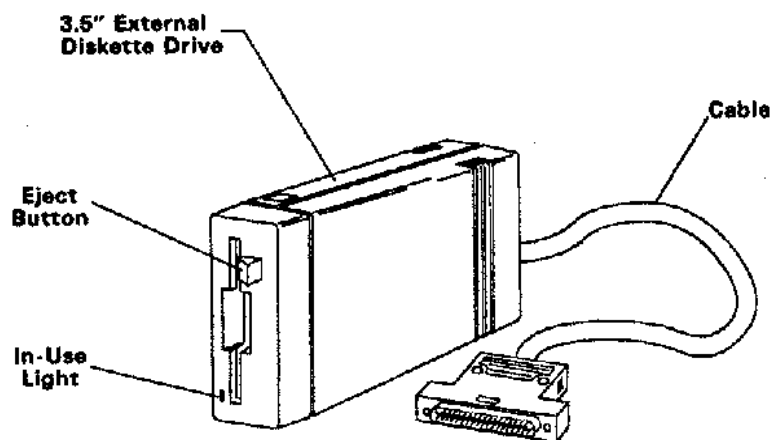

Setup Procedures

Before you use the diskette drive for the first time, make sure that the shipping cardboard has been removed from the drive.

Removing the Shipping Cardboard

Press the eject button to remove the shipping cardboard.

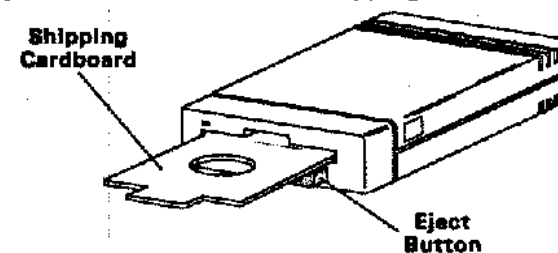

Attaching the Diskette Option

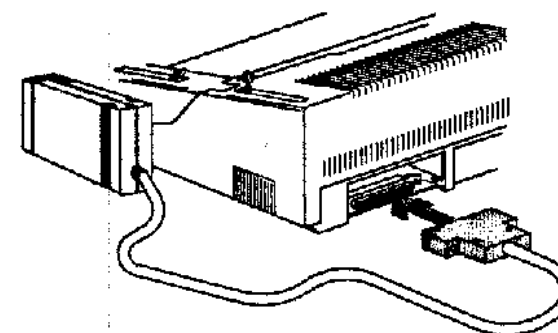

1. Make sure the typewriter is turned off.
2. Push the Diskette Option cable plug into the socket located in the rear of the typewriter. Use the shape of the plug as a guide for attaching it properly.
3. Tighten the screws.
4. Turn the typewriter on.

Note: If an error code is displayed when you turn the typewriter on, see Chapter 8 for help.

Placement of the Diskette Drive

Place the diskette drive on a *flat surface*, such as a desk top. Do not place the diskette drive on top of books or papers.

The diskette drive may be placed in either a vertical or horizontal position.

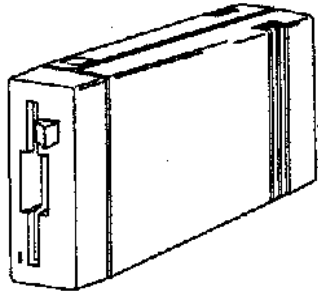

Vertical
Position

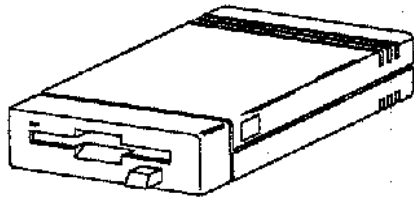

Horizontal
Position

Definition of Terms

Read the following terms and definitions to become familiar with them.

- *Diskette*. A diskette is a magnetic storage medium (3.5 inch) on which jobs are stored. It may also be referred to as a disk, floppy disk, or minidisk. The term diskette is used in this manual.
- *Diskette Drive*. A diskette drive is a device used to gain access to the jobs stored on a diskette.
- *Job*. A job is anything you type and store on your typewriter. A job can be a word, line, sentence, paragraph, page, or several pages.
- *Write-Protected*. Write-protected means the write-protect tab is locked so that you cannot delete or store over jobs already stored on the diskette.

Using and Handling Diskettes

Use only 3.5 inch double-sided, double-density diskettes, such as IBM 1MB capacity diskette (PN6404107).

Handle your diskettes with care at all times to keep from damaging them or losing jobs stored on them. The following precautions will help you take care of your diskettes:

- Do not place diskettes near food, drink, or ashtrays.
- Do not place diskettes near materials that might be magnetized. All of the jobs stored on the diskette will be lost.
- Keep the diskettes away from heat greater than 125 degrees Fahrenheit (51.5 degrees Celsius) or direct sunlight.

Write-Protecting Diskettes

You can write-protect a diskette so that jobs cannot be stored on or erased from the diskette. Follow these steps to check whether a diskette is write-protected:

1. Hold the diskette in your hand so the label is away from you.
2. Notice the write-protect tab and the small opening in the corner of the diskette, as shown below. If you can see through this opening, the diskette is write-protected.
 - *To permit storing on the diskette:* slide the write-protect tab to the closed (unprotected) position.
 - *To write-protect the diskette:* slide the tab to the open (protected) position. You can see through the tab opening.

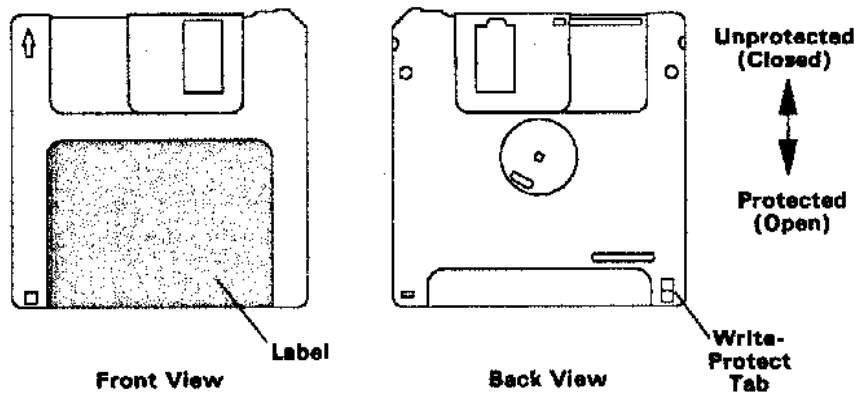

Inserting a Diskette

Important: Never insert a diskette while the In-Use light is on. If you do, stored jobs will be lost. See page B-2 for the location of the In-Use light.

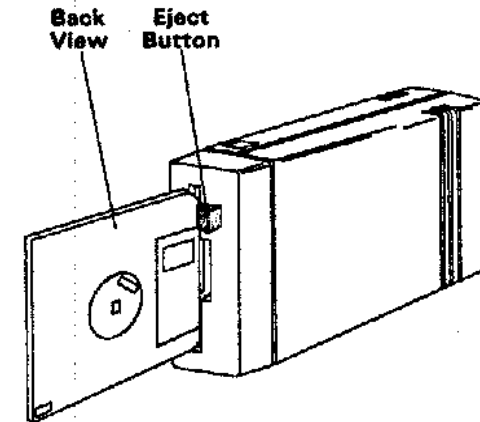

1. Insert the diskette into the drive so that the printed label on the diskette faces away from the blue eject button on the diskette drive.
 - Make sure the diskette clicks into place.
2. Turn the typewriter on. The Diskette option automatically comes on when you turn the typewriter on.

Removing a Diskette

Important: Do not remove a diskette while the In-Use light is on, or when the DISKETTE BUSY indicator is displayed. If you do, stored jobs will be lost. See page B-2 for the location of the In-Use light.

Press the blue eject button on the front of the diskette drive to remove the diskette. The diskette ejects from the drive.

Preparing a Diskette

Before you can use a diskette for the *first* time, you must prepare it. A diskette only needs to be prepared once. Preparing a diskette again deletes all jobs on the diskette. Preparing the diskette allows you to store jobs on the diskette. You start the PREPARE function through the menu.

1. Press the Menu key. The following information is displayed:

```
USE ← → TO POSITION AND PRESS CRtn TO SELECT OR PRESS C TO CANCEL
D|IRECTORY LIST PAGE-FORMAT D|ISKETTE COPY SPELL
```

2. Select DISKETTE.

```
USE ← → TO POSITION AND PRESS CRtn TO SELECT OR PRESS C TO CANCEL
D|IRECTORY LIST PAGE-FORMAT D|ISKETTE COPY SPELL
```

3. Select PREPARE.

```
USE ← → TO POSITION AND PRESS CRtn TO SELECT OR PRESS C TO CANCEL
D|IRECTORY LIST TITLE PREPARE
```

4. Insert a diskette, then press CRtn to prepare the diskette.

```
INSERT DISKETTE AND PRESS CRtn TO PREPARE OR PRESS C TO CANCEL
```

If the diskette was previously prepared, the following message is displayed:

```
DISKETTE TEXT WILL BE LOST: PRESS CRtn TO CONTINUE OR PRESS C TO CANCEL
```

Note: Pressing CRtn will erase all jobs previously stored on the diskette. If you do not want to prepare the diskette, press the Correction key to cancel.

The DISKETTE BUSY indicator is displayed during preparation.

If a diskette problem occurs during diskette preparation, the following message is displayed:

```
DISKETTE NOT USABLE: INSERT NEW DISKETTE AND PRESS CRtn OR PRESS C TO CANCEL
```

- a. Press the Correction key to cancel; or
 - b. Insert a different diskette, then press CRtn to continue.
5. When the following message is displayed, type the title of the diskette.

```
TYPE DISKETTE TITLE: |
```

- A diskette title is not required, but naming helps you identify the diskette.
 - A title may have 1 to 50 characters; for example, it may consist of a letter of the alphabet, a number, a day of the week, or a specific job name (Wills, Lease Agreements, Form Letters, The Welman Report, or mailing list).
6. Press CRtn. The DISKETTE PREPARATION COMPLETE message is displayed.
 7. Press any key to clear the message from the display, then remove the diskette. You may label the diskette using any writing instrument.

Diskette Storage

Before you begin this section, you should be familiar with using storage on your typewriter as discussed in Chapters 3 and 4, and with the use of the Menu key. For details on storage and the Menu key, see pages 3-1 through 4-19.

This section explains how to use the Diskette Option for storing jobs.

Important: Do not turn the typewriter off or remove a diskette while the In-Use light is on, or when the DISKETTE BUSY indicator is displayed. If you do, stored jobs will be lost. See page B-2 for the location of the In-Use light.

When you revise a job on the diskette, the diskette job is temporarily kept in typewriter storage. Therefore, the amount of space available for revising a diskette job is determined by the amount of unused typewriter storage. The following message is displayed if the diskette job is too large:

INSUFFICIENT TYPewriter STORAGE; USE DEL TO DELETE STORAGE AREAS

Storing all jobs on diskette provides the most space in typewriter storage for revising diskette jobs. If you already have several jobs stored in typewriter storage, you may want to copy them to diskette before deleting them from typewriter storage. See "Copying Jobs" on page B-18 for more information.

Diskette storage is similar to typewriter storage in that all operations described for typewriter storage are functional in diskette storage. You may find it useful to think of diskette storage as an extension of typewriter storage. For example, you can store a job in storage area 1 on the typewriter. You can also store a job in storage area 1 on the diskette.

You learned to open a storage area on your typewriter by holding down Store while you type a number (1 through 99). For example, to use storage area 5 on the typewriter, press:



To store on a diskette, hold down Store while you press = (equal) and a number (1 through 99). For example, to use storage area 1 on a diskette, press:



Note: You do not need to keep holding the = (equal) key down while typing the job number.

Storing a Job on a Diskette

1. Hold down **Store** while you press **=** (equal) and a number (1 through 99) where you want to store the job.
2. Release all keys.
3. Type the job.
4. Press **Store** to close diskette storage.

Note: See pages 3-1 to 3-3 for more information on storing jobs.

Playing Back a Job Stored on a Diskette

1. Press **Format** to check margin and tab settings before playing back your job.
2. Hold down **Play** while you press **=** (equal), then type the number (1 through 99) where you stored the job.
3. Release the keys.
 - Playback begins immediately.

Note: See pages 3-4 to 3-7 for more information on playback.

Identifying the Current Diskette Storage Area

As you store or revise a job on the diskette, you may want to know which storage area is open. To identify a diskette storage area, use the **Menu** function as you did to identify a typewriter storage area. The only difference in the display message is that an equal (=) sign appears with the diskette storage area. For example: =5. If you need help, see page 4-1.

Diskette
Storage
Area

USE ← → TO POSITION AND PRESS CRtn TO SELECT OR PRESS CB TO CANCEL → ←
DIRECTORY LIST PAGE-FORMAT DISKETTE COPY SPELL

Revising a Job Stored on a Diskette

1. Hold down **Store** while you press **=** and the number where you stored the job.
2. Release all keys.
3. Revise the job.
4. Press **Store** to close diskette storage.

Note: See pages 3-14 to 3-24 for more details.

Deleting a Job Stored on a Diskette

1. Hold down **Del** while you press **=** and the number of the diskette storage area you want to delete.
2. Press **Del** again to delete the diskette storage area.

Note: For more information about deleting stored information, see page 3-17.

Canceling Delete

Press the **Correction** key to cancel delete when the following message is displayed:

PRESS Del AGAIN TO DELETE STORAGE =2 OR PRESS CB TO CANCEL

Deleting All Diskette Storage Areas

Use the **PREPARE** function to delete *all information* on a diskette. See "Preparing a Diskette" on page B-8 for more information.

Quit Revision without Storing

Follow the steps below to quit the job you have been revising *without* storing any revisions on the diskette.

1. Remove the diskette from the diskette drive.
2. Press **Store** to close storage. The following message is displayed:

INSERT DISKETTE AND PRESS CRtn TO CONTINUE, OR TO CANCEL, OR Del TO DELETE

3. Press **Del**.
4. Press **Del** again.

Using More than One Diskette

When you revise a diskette job, the typewriter remembers the diskette where the job was stored. If you place a different diskette containing a job with the same number in the drive and press **Store** to close storage, the following message is displayed:

DISKETTE WAS EXCHANGED. PRESS CRtn TO CONTINUE OR PRESS Del TO CANCEL

Do one of the following:

- To store your revisions on the original diskette, insert the correct diskette in the drive and press **CRtn**.
- Press **CRtn** without changing the diskette to store your revisions on the diskette in place of the job on that diskette.
- Press the **Correction** key to return to revision without storing the job.

The typewriter also remembers the diskette from which a job is played. When diskette playback is stopped, some of the displayed text is read from the diskette. If a different diskette is in the drive when the typewriter updates the display, the message above is displayed. To continue, you must insert the correct diskette in the drive and press **CRtn**. Pressing the **Correction** key cancels playback.

Diskette Directory and List

Diskette Directory and Diskette List work in much the same way as the Directory and List functions discussed in Chapter 5.

Diskette Directory and Diskette List may look slightly different from the actual contents of your diskette job. For example, text which has been typed using the Bold, Underline, Superscript, and Subscript functions will be displayed as normal text.

Note: Information from other equipment, such as an IBM Personal Typing System™ or an IBM Personal System/2®, can be stored on the diskette. The following text is displayed just before the diskette title to indicate the presence of this information:

=?? ????????

You must use the diskette with the appropriate equipment to gain access to the information.

Diskette Directory

The Diskette Directory function displays a list of the contents of the diskette currently in the diskette drive. The directory also displays the amount of storage space remaining on the diskette and the amount used for each job. All typewriter Directory functions are available with the diskette directory.

Viewing the diskette directory is similar to viewing the typewriter directory:

1. Press the **Menu** key.
2. Select **DISKETTE**.
3. Select **DIRECTORY**.
4. Read and follow the instructions that appear on the display. If you need help, refer to steps 2 through 6 on pages 4-3 and 4-4.

Note: The diskette title is displayed as the last item of the Diskette Directory. Press **End** to view the diskette title.

Diskette List

The Diskette List function is used to print a copy of the diskette directory. The printout is the same as the List function printout, with two exceptions:

- An equal sign (=) appears with the number of each diskette storage area.
- The diskette title (if any) is printed at the top of the list.

Printing a List of the Diskette Directory

1. Make sure paper is in the typewriter.
2. Press the Menu key.
3. Select DISKETTE.
4. Select LIST.
 - The printed list should be similar to the example below.

```
682158 TITLE: The Welman Report          012::055 20000
= 1 (Proposal)                          020::090 10000
= 2 In the late nineteenth centur
```

Note: For more information about listing jobs, see page 4-6.

Changing or Checking the Title of the Diskette

You have already learned that you give a diskette a title when you are preparing the diskette. You may want to change or check a diskette title without erasing the jobs on the diskette. To check or change a diskette title:

1. Press the Menu key.
2. Select DISKETTE.
3. Select TITLE.
4. After a few seconds, the following message is displayed, followed by the current diskette title.

```
TYPE DISKETTE TITLE: _____ $1
```

5. Press the Correction key to keep the current title.
6. If you want to change the diskette title, type the new title. When you begin typing the new title, the old title is automatically erased from the display.
 - If you decide not to change the title after you have typed part of a new title, press the Correction key until the title is blank. Then press the Correction key once more to cancel the Title function.
7. Press CRtn to store the new title on the diskette.

Copying Jobs

With the Diskette Option installed, you can copy jobs in many different ways, for example:

- From diskette to typewriter storage.
- From typewriter storage to diskette.
- From one diskette storage area to another diskette storage area on the same diskette.
- From one typewriter storage area to another typewriter storage area.

When copying to diskette, make sure the diskette you are copying to has been properly prepared. See page B-8 for more information.

1. Press the **Menu** key.
2. Select **COPY**.
3. When the copy message appears, type the number of the storage area to copy **"FROM"**.
4. Press the **Tab** key to move the cursor to the next position.
5. Type an **=** (equal) followed by the number of the storage area you want to copy **"TO"**.
6. Press **CRtn**.

For example, to copy from typewriter storage area 1 to diskette storage area 9:

```
COPY FROM STORAGE NUMBER: 1 TO STORAGE NUMBER: 9
```

Copying from One Diskette to Another Diskette

1. Open the diskette storage area where the job you want to copy is stored.
2. Remove the first diskette from the diskette drive.
3. Insert the second diskette into the diskette drive.
4. Copy the diskette storage area onto the second diskette.
5. Remove the second diskette from the diskette drive.
6. Press **Store** to close storage.
7. When the **INSERT DISKETTE** message is displayed, press **Del** two times.

Helpful Hints

- If you have an IBM Personal Typing System™ or an IBM Personal System/2e, you can copy an entire diskette at one time. For details, see the manual that came with your system.

Index

S

§ (section) symbol 2-11

T

¶ (paragraph) symbol 2-11

A

accent marks 6-2
adding text in No Print 3-22
adding text to a stored job 3-16, 3-20
adding words to the supplemental dictionary A-4
adjusting keyboard height 1-10
adjusting the display 1-4
advanced operations 2-1
advanced storage 5-1
advancing to a find point 5-7
aligning text to the right margin 2-7
allowing hyphenated words to separate at a line ending 3-12
alphabetic keyboard
cross-reference 6-3
alternate keyboards 6-1
ASCII (PC) 6-9
Australia 6-4
Austria 6-4
Belgium 6-10
Brazil 6-7
Canada (Bilingual) 6-5
Canada (English) 6-4
Denmark 6-6
Finland 6-6
France 6-10
Germany (PC) 6-10
Germany (West) 6-4
Greece (Greek) 6-9
Greece (Latin) 6-9
Hong Kong 6-9
Italy 6-5
Italy (PC) 6-10

Japan (English) 6-7
Latin America 6-4
Latin Supplemental ISO 6-8
Netherlands 6-5
New Zealand 6-4
Norway 6-6
Portugal 6-7
South Africa 6-8
Spain 6-8
Sweden 6-6
Switzerland (French) 6-5
Switzerland (German) 6-6
Turkey 6-8
United Kingdom 6-7
United Kingdom (PC) 6-10
United States 6-4

alternate spellings, choosing A-7
APAGE Indicator 1-7, 4-13, 8-16
applications, printwheels 7-4, 7-5
applications, ribbons 7-10
ARTN Indicator 1-7, 2-1, 4-17, 5-4, 5-7, 5-27, 8-16
ARtn key 2-1
ASCII (PC) keyboard 6-9
assembling documents 5-18
Character and Delay Print 5-19
during playback 5-20
No Print 5-19
storage 5-18
Australia keyboard 6-4
Austria keyboard 6-4
Auto Page End 4-9, 4-13
canceling 4-14
playing back jobs 4-13
using with Required Page End 5-29
Automatic Carrier Return 2-1
revising tables, columns, and forms 3-16
turning on and off 2-1
typing tables, columns, and forms 2-1, 3-25, 3-30
automatic erase 1-27
automatic pitch selection 1-19

B

B (Bold) key 2-11
Backspace (Bksp1) key 1-31, 1-32
basic operations 1-1
batch spell check A-6
batteries
 checking 7-13
 installing 7-15
 removing 7-14
battery recommendations 7-12
beep signals, messages and error codes 8-8
beep signals, messages and indicators without 8-10
beginning playback 3-6
Belgium keyboard 6-10
Bksp1 key 1-31, 1-32
BOLD indicator 1-7, 2-11, 8-16
Bold key 2-11
bold print 2-11
 symbol 1-6, 2-11, 8-15
bottom margin
 calculating 4-11
 common settings 4-12
 setting 4-10
Brazil keyboard 6-7
BUSY indicator 1-3, 1-7, 8-16

C

C (Ctr) key 2-5
calculating page length and bottom margin 4-11
Canada (Bilingual) keyboard 6-5
Canada (English) keyboard 6-4
cancel
 Auto Page End 4-14
 delete 3-28
 Directory 4-4
 List 4-6
 Menu 4-2
 playback 3-7
 Right Flush before characters print 2-8
 Tab Adjust 4-16
 temporary margins 2-13
CAPS indicator 1-7, 1-17, 8-16
Caps key 1-17
carbon copies, inserting 1-12
cardholder 1-16
care and maintenance 7-16
carrier limits, margins at 1-23
carrier movement keys 1-14
carrier return, automatic 2-1
carrier returns, deleting extra 3-23
CENTER indicator 1-7, 2-5, 8-16
centered text, erasing 2-6
centered text, revising in No Print 3-27
centering 2-5
 at any point on a line 2-6
 between margins 2-5
 changing printwheels 2-20
 symbol 1-6, 2-5, 8-15
centering marks 1-20
Change
 repeating 5-13
 revising stored jobs 5-12
changing line spacing 1-9
changing pitch 2-21
changing pitch or typestyle in justified text 2-19
changing printwheels during playback 3-26
changing printwheels in delay print, centering, right flush, or decimal tab 2-20
changing printwheels while typing 2-20, 3-31
changing the spelling beep sound A-8
changing top margin 2-22
changing typestyle 2-20
character erase 1-27
Character Print mode 2-17
 assembling documents 5-19
 changing from No Print in revision 3-14, 3-27
 revising stored jobs 3-15
characters per horizontal inch 1-19
charts, keyboard 6-4
checking all words in a job A-6
checking batteries 7-13
Chng key 5-12, 5-13

choosing a print mode 2-17
choosing a printwheel 1-18
choosing alternate spellings A-7
cleaning the typewriter cover 7-16
clearing all tabs 1-22
clearing tabs 1-22
clearing temporary margins 2-12
clearing the correction memory 1-26
clicker, keyboard 1-11
closing storage 3-2
Code key 1-5
 and ; (\$) 2-11
 and - (hyphen) 2-3, 3-12
 and] (") 2-11
 and ± A-7
 and ½ (°) 2-11
 and ' (") 2-11
 and **B (Bold)** 2-11
 and **Backspace (Bksp1)** 1-31, 1-32
 and **C (Ctr)** 2-5
 and **CRtn (IndClr)** 2-12
 and **D (DecT)** 2-14
 and **E (PgEnd)** 5-29
 and ← (**Word**) 1-14, 3-21
 and **H (½ ↓)** 2-9
 and ↑ (**Line**) 1-13
 and **I (Word)** 2-4
 and **L (Lang)** 6-2
 and **N (Caps)** 1-17
 and ↓ (**Line**) 1-13, 3-21
 and **O (RFlsh)** 2-7
 and **Paper Ball Load Lever** 2-22
 and **Paper Down (Micro)** 1-13
 and **Paper Up (Micro)** 1-13, 2-16
 and **Q (Impr)** 1-15
 and **R (ARtn)** 2-1, 5-4
 and **Reloc (Line Space)** 1-9
 and **RMar (IndR)** 2-12, 3-10
 and **S (keyboard clicker)** 1-11
 and **Shift + Del** 3-28
 and **Shift + M (Mark)** 5-24
 and **Spacebar** 2-3
 and → (**Word**) 1-14
 and **Tab (IndL)** 2-12, 3-10
 and **U (Cont)** 2-4, 2-16

and **Y (½ ↑)** 2-10
 and **1** A-3
 and **2** A-4, A-6
 and **3** A-5
 and **4** A-8
 and **9 (Stop)** 2-20, 3-29, 5-26
columns
 double underlining 2-16
 moving 4-15
 storing 3-25
 typing with decimals 2-14
 typing without decimals 2-15
 underlining 2-16
combining Find with delete 5-10
combining Find with Play 5-10
combining jobs 5-18
common page-layout settings 4-12
constant text, typing in a form 5-24
CONT indicator 1-7, 2-4, 8-16
Cont key 2-4
continuing playback 3-6
continuous underline 2-4
contrast knob 1-4
copying jobs for revision 3-14
correcting a form layout 5-28
correcting errors with storage closed 3-20
Correction (Word) key 1-27
correction memory 1-26, 5-28
 clearing 1-26
 erasing outside 1-29, 1-30
correction point, playing back to 3-20
correction tape, matching with ribbon 7-8
corrections
 adding text 3-20
 deleting text 3-20
cross-reference, keyboard alphabetic 6-3
CRtn (IndClr) key 2-1, 2-12
Ctr key 2-5
current carrier position 1-23
current storage area, identifying 4-1
cursor movement keys 1-14
cursor, defined 1-5

D

- D (DecT) key 2-14
- dead keys 6-2
- DEC T Indicator 1-7, 2-14, 8-16
- decimal tabulation 2-14
 - begin symbol 1-8, 8-15
 - changing printwheels 2-20
 - end symbol 1-8, 8-15
- DecT key 2-14
- Del and Find 5-10
- Del key 3-17, 3-22, B-13
- Delay Print mode 2-17
 - assembling documents 5-19
 - changing from No Print in revision 3-14, 3-27
 - changing printwheels 2-20
 - revising stored jobs 3-15
- delete
 - all storage areas 3-28
 - canceling 3-28
 - jobs using the Directory function 4-5
 - stop codes 3-30
 - stored jobs 3-28
 - text from a job 3-17, 3-20
 - text in No Print 3-22
 - to a find point 5-10
 - words from the supplemental dictionary A-5
- deleting extra carrier returns 3-23
- Denmark keyboard 6-5
- determining problems 8-1
- dictionary, supplemental A-4
 - adding words A-4
 - deleting words A-5
 - viewing and deleting words A-5
- Directory 4-3
 - canceling 4-4
 - defined 4-2
 - deleting jobs 4-5
 - locating job numbers 4-5
 - moving through 4-4
 - playing back jobs 4-4
 - printing copies 4-6
 - revising jobs 4-4
 - using Find with 4-5

- Diskette Option B-1
 - attaching the diskette drive B-3
 - checking and changing diskette title B-17
 - copying jobs B-18
 - copying jobs from diskette to diskette B-19
 - definition of terms
 - diskette B-5
 - diskette drive B-5
 - job B-5
 - write-protected B-5
 - deleting all storage areas B-13
 - deleting stored jobs B-13
 - Directory B-15
 - DISKETTE BUSY indicator B-7, B-8
 - diskette drive placement B-4
 - exchanging diskettes B-14
 - functions B-2
 - identifying the current storage area B-12
 - inserting a diskette B-7
 - List B-15, B-16
 - messages 8-18
 - playing back jobs B-12
 - preparing diskettes B-8
 - problems 8-7
 - quit revision without storing B-14
 - removing a diskette B-7
 - removing the shipping material B-3
 - revising stored jobs B-13
 - setup procedures B-3
 - storing jobs B-10, B-12
 - using and handling diskettes B-5
 - using more than one diskette B-14
 - write-protecting diskettes B-6
- display 1-5
 - adjustment 1-4
 - indicators 1-7, 8-16
 - problems 8-3
 - symbols 1-6, 8-15
- displaying margin and tab formats 1-23, 3-8
- DL PRT indicator 1-7, 2-17, 8-16
- document assembly 5-18

- Character and Delay Print 5-19
 - No Print 5-19
 - outside of storage 5-20
 - storage 5-19
 - double underlining numbers in a column 2-16
 - drawing vertical lines 1-16
- ## E
- End key 5-7
 - ending lines before the right margin 2-2
 - erase 1-27
 - centered text 2-6
 - character 1-27
 - manually in proportional spacing 1-30
 - manually in 10, 12, 15 pitch 1-29
 - outside the correction memory 1-29, 1-30
 - problems 8-3
 - proportional spacing 1-30
 - word 1-27
 - error codes and messages with beep signals 8-8
 - error messages 8-10
 - errors, correcting with storage
 - closed 3-20
 - even left and right margins, typing text with 2-18
 - even right margin 2-7
 - extra carrier returns, deleting 3-23
 - extra character, inserting 1-32

F

- Find 5-7
 - combining with delete 5-10
 - combining with hyphenation 5-7
 - combining with Play 5-10
 - repeating 5-8
 - used with the Directory function 4-5

- Find key 4-5, 5-7
- Find point
 - advancing to 5-7
 - deleting to 5-10
 - playing to 5-10
- Finland keyboard 6-6
- flush right 2-7
- form layouts
 - correcting 5-28
 - playing back 5-27
 - storing 5-28
 - typing constant text 5-24
 - typing variable text 5-24
 - using Mark 5-24
- form letters 3-31
 - playing back 5-17
 - storing with stop codes 5-16
 - typing 5-16
- format areas
 - saving 1-24
 - selecting 1-25
- formats
 - defined 1-23
 - displaying 1-23, 3-8
 - margin and tab 1-23
 - margin and tab, in stored jobs 3-8
 - selecting settings 1-24
 - storing 1-24
- France keyboard 6-10
- Format key 1-23, 3-8
- Format key, pressing while storage is open 3-8
- function keys 1-8

G

- Germany (PC) keyboard 6-10
- Germany (West) keyboard 6-4
- glass, reducing on display 1-4
- Greece (Greek) keyboard 6-9
- Greece (Latin) keyboard 6-9

H

- H ($\frac{1}{2}$ ↓) key 2-9
- Home key 5-7
- Hong Kong keyboard 6-9
- HYPHEN indicator 1-7, 2-1, 3-12, 5-3, 8-16
- Hyphen, turning on and off 2-1
- hyphenated word, keeping on one line 3-12
- hyphenated words, separating at a line ending 3-12
- hyphenating a word 5-4
- hyphenation
 - during playback 5-3
 - keeping a word on the same line 5-4
 - moving a word to the next line 5-4
 - turning on and off 5-4
- hyphenation combined with Find 5-7
- hyphens
 - permanent 3-12
 - required 2-3
 - syllable 3-11
 - typing in a stored job 3-11

I (Word) key 2-4

- ID number, keyboard 6-1
- Identifying the current storage area 4-1
- Identifying the printwheel 1-18
- Illustrations
 - calculating Page-Layout settings 4-11
 - Center symbol 2-5
 - Code + the Correction key 1-27
 - coded keys 1-8
 - Correction key 1-27
 - diskette Directory listing B-16
 - diskette drive B-2
 - diskette drive placement B-4
 - Diskette Option installation B-3
 - Diskette Option shipping material removal B-3
 - diskette write-protect tab B-6

- erasing manually in proportional spacing 1-31
- Inserting a diskette B-7
- Inserting an extra character 1-32
- Inserting paper 1-12
- installing batteries 7-15
- installing ribbon cassettes 7-9
- installing the printwheel 7-7
- keyboard height adjust levers 1-10
- keyboard identification number 6-1
- keyboard layout 1-2
- margin/pitch scale 1-20
- Mark symbol 5-26, 5-28
- opening a diskette storage area B-11
- opening a typewriter storage area B-11
- page end indicator and scale 1-11
- paper, carrier and cursor movement keys 1-13
- parts of the typewriter 1-1
- Print Mode key 2-17
- printwheel identification 1-18
- printwheel pitch 1-19
- Reloc key 1-28
- removing a diskette B-7
- removing batteries 7-14
- removing ribbon cassettes 7-8
- removing the printwheel 7-6
- removing the printwheel shipping seal 7-7
- ribbon cassette system 7-8
- sample of justified text 2-19
- sample preprinted form 5-25
- Spell Check keys A-2
- stopping playback while printing
 - left to right 3-6
- temporary left and right margins 2-12
- typematic keys 1-9
- typestyle samples and pitches 7-2, 7-3
- typewriter serial number 7-16
- using stop codes for form letters 5-16

- IMPR Indicator 1-7, 1-15, 8-16
- Impression control 1-15
- Impression level, setting 1-15
- Indent 2-12, 3-9
 - clear symbol 1-6, 2-13, 8-15
 - left symbol 1-6, 2-12, 8-15
 - right symbol 1-6, 2-12, 8-15
- index, problem determination 8-2
- indicators
 - APAGE 1-7, 4-13, 8-16
 - ARTN 1-7, 2-1, 8-16
 - BOLD 1-7, 2-11, 8-16
 - BUSY 1-3, 1-7, 8-16
 - CAPS 1-7, 1-17, 8-16
 - CENTER 1-7, 2-5, 8-16
 - CONT 1-7, 2-4, 8-16
 - DECT 1-7, 8-16
 - DL PRT 1-7, 2-17, 2-18, 8-16
 - HYPHEN 1-7, 2-1, 3-12, 5-3, 8-16
 - IMPR 1-7, 1-15, 8-16
 - JSTIFY 1-7, 2-18, 6-1, 8-16
 - KYBD 1-7, 8-2, 8-16
 - LO-BAT 1-7, 7-13, 8-16
 - NO PRT 1-7, 2-17, 8-16
 - PLAY 1-7, 3-5, 8-16
 - RFLUSH 1-7, 2-7, 8-16
 - SHIFT 1-7, 1-17, 8-16
 - SPELL 1-7, 8-16, A-3
 - STORE 1-7, 3-1, 8-16
 - SUSPND 1-7, 5-19, 8-16
 - T ADJ 1-7, 4-16, 8-16
 - WHEEL 1-7, 2-21, 3-26, 8-16
- indicators without beep signals 8-10
- indicators, defined 1-5
- indicators, display 1-7, 8-16
- IndL key 2-12
- IndR key 2-12
- Inserting an extra character 1-32
- Inserting carbon copies 1-12
- Inserting paper 1-12
- installing new batteries 7-15
- installing printwheels 7-7
- installing ribbon cassettes 7-9
- Italy (PC) keyboard 6-10
- Italy keyboard 6-5

J

- Japan (English) keyboard 6-7
- Job numbers, locating in the directory 4-5
- Job titles 3-31
- JSTIFY indicator 1-7, 2-18, 6-1, 8-16
- Justify key 2-18
- Justification 2-18
 - changing pitch or typestyle during 2-19
 - during playback 5-1
 - multipage jobs 5-2
 - sample printout 5-1
 - turning on and off 2-18

K

- keeping a hyphenated word on one line 3-12
- keyboard
 - changes 3-31
 - charts 6-4
 - identification number 6-1
 - layout 1-2
 - problems 8-4
- keyboard alphabetic cross-reference 6-3
- keyboard clicker 1-11
- keyboard height adjust levers 1-10
- keyboards
 - alternate 6-1, 6-2
 - matching with printwheels 6-1
 - primary 6-1
- keys
 - Backspace (Bksp1) 1-31, 1-32
 - C (Ctr) 2-5
 - Chng 5-12, 5-13
 - Correction (Word) 1-27
 - CRtn (IndClr) 2-1, 2-12
 - D (DeCT) 2-14
 - Del 3-14, 3-17, 3-22, B-13
 - End 3-6, 3-21, 5-7
 - Find 4-5, 5-7
 - Format 1-23, 3-8
 - H ($\frac{1}{2}$ ↓) 2-9

Home 3-21, 5-7
I (Word) 2-4
Justify 2-18, 5-1
L (Lang) 6-2
LMar 1-21
Lock 1-17
Menu 4-1, A-5
N (Caps) key 1-17
O (RFlsh) 2-7
Paper Down (Micro) 1-13
Paper Up (Micro) 1-13
Play 3-5
Print Mode 2-17
O (Impr) 1-15
R (ARtn) 2-1
Reloc (Line Space) 1-14, 1-28
RMar (IndR) 1-21, 2-12
Shift 1-17
Store 3-2
Tab (IndL) 1-22, 2-12
U (Cont) 2-4
Y (½ ↑) 2-10
keys, dead 6-2
keys, function 1-8
keys, paper, carrier and cursor movement 1-13
keys, typematic 1-9
KYBD indicator 1-7, 6-2, 8-16

L

L(Lang) key 6-2
last typing position, returning 1-28
latching the ribbon cassettes together 7-9
Latin America keyboard 6-4
Latin Supplemental ISO keyboard 6-8
left and right temporary margins 2-12
left carrier limit 1-23
left margin, releasing 1-21
line space in stored jobs 3-4, 3-30
Line Space key 1-9
line space symbol 1-6, 1-9, 8-15
lines per vertical inch 1-19
List 4-6
List defined 4-2
listing jobs stored 4-3, 4-6

LMar key 1-21
LMar, pressing with storage open 3-9
LO-BAT indicator 1-7, 7-13, 8-16
loading paper 1-12
locating job numbers in the directory 4-5
Lock and Shift keys 1-17

M

maintenance and care 7-16
manual erase 1-29
margin and tab formats 1-29
margin and tab formats in stored jobs 3-8
margin release key 1-21
margin/pitch scale 1-20
margins
centering between 2-5
changing after opening storage 3-9
displaying 1-23
releasing 1-21
setting bottom 4-10
setting left and right 1-21
setting temporary 2-12
setting top 2-22

Mark

correcting the form layout 5-28
playing back the form layout 5-27
preprinted forms 5-24
storing a form layout 5-28
symbol 1-6, 5-28, 8-15

MarRel key 1-21

matching printwheels and keyboards 3-26, 6-1
matching ribbon and correction tape 7-8
memory, correction 1-26, 5-28
menu functions 4-1
Auto Page End 4-13
Directory 4-3
List 4-6
Page-Format 4-9
Page-Layout 4-10
Spell A-5
Tab Adjust 4-15
Menu key 4-1, A-5

Menu, canceling 4-2
Menu, selecting functions 4-2
messages

defined 1-6
Diskette Option 8-18
Spelling function 8-18
typewriter 8-17
with beep signals 8-8
without beep signals 8-10

micro-down 1-13

micro-index defined 1-13

micro-up 1-13

moving a word to the next line 5-4

moving paper in the typewriter 1-13

moving tabs

during playback 4-17

in a portion of a stored job 4-18

in a stored job 4-15

throughout a stored job 4-17

moving the carrier and cursor 1-14

moving through storage 3-21

moving through the directory 4-4

multipage jobs, justifying 5-2

multipage jobs, separating pages 4-13, 5-29

N

N (Caps) key 1-17

Netherlands keyboard 6-5

New Zealand keyboard 6-4

no margins and tabs set 1-23

No Print mode 2-17

adding text 3-22

assembling documents 5-19

changing to Character or Delay

Print In revision 3-14, 3-27

deleting text 3-22

revising a stored job 3-21

NO PRT indicator 1-7, 2-17, 8-16

Norway keyboard 6-6

numbers in a column,

underlining 2-16

O

O (RFlsh) key 2-7

on/off switch 1-3

opening storage 3-2, 3-21

ordering supplies 7-1

overview, playback 3-4

overview, revision 3-14

overview, storage 3-1

P

page end indicator 1-11

page end scale 1-11

page end, auto 4-13

page end, required 5-29

page length, calculating 4-11

page length, setting 4-10

Page-Format 4-9

Page-Format defined 4-2

Page-Layout 4-9, 4-10

Page-Layout settings for Pinwheel

Form Feeder 4-12

paper

inserting 1-12

problems 6-4

removing 1-14

Paper Bail Load Lever 1-12, 1-14, 2-22

Paper Down (Micro) key 1-13

paper edge indicator 1-12

paper length, common settings 4-12

paper movement keys 1-13

paper release lever 1-12, 1-14

paper scale 1-12

Paper Up (Micro) key 1-13

parts of the typewriter 1-1

permanent hyphen defined 3-12

permanent tabs 1-22

Pinwheel Form Feeder 4-12

pitch

automatic selection 1-19

change symbol 1-6, 8-16

changing 2-21

changing in justified text 2-19

defined 1-19, 2-21

identified on printwheel label 1-18
symbols 1-19, 7-1
WHEEL indicator 2-21, 3-26
PLAY indicator 1-7, 3-5, 8-16
Play key 3-5
playback
assembling and storing 5-20
beginning 3-5
canceling 3-7
continuing 3-6
defined 3-4
hyphenating 5-3
justifying 5-1
moving tabs 4-17
rules 3-26
stopping 3-6
storage closed 3-4
storage open 3-15
to a correction point 3-20
to a find point 5-10
to a revision point 3-15
playing back
form layouts 5-27
form letters 5-17
jobs containing required page ends 5-29
jobs containing stop codes 3-30
jobs with Adjust-Page on 4-13
jobs with Tab Adjust on 4-17
jobs with the Directory function 4-4
storage open 3-15
stored jobs 3-4
with storage closed 3-4
Portugal keyboard 6-7
power on/off 1-3
preprinted forms, using Mark 5-24
pressing Fmat while storage is open 3-8
pressing LMar with storage open 3-9
pressing RMar with storage open 3-9
primary keyboard 8-1
print hammer 7-6
Print Mode key 2-17
print modes 2-17
print quality problems 8-4
printing a copy of the directory 4-8
printing line 1-16

printwheel
applications 7-4, 7-5
changing during playback 3-26
changing while typing 2-20
choosing 1-18
identification 1-18
identification numbers 8-1
installing 7-7
matching with keyboards 8-1
pitch chart 1-19
pointer 1-16, 1-18, 1-31
removing 7-6
reorder number 1-18
problem determination 8-1
Diskette Option messages 8-18
display 8-3
display indicators 1-7, 8-16
erase 8-3
error codes 8-8
index 8-2
keyboard 8-4
messages without beep signals 8-10
print quality 8-4
Spell Check 8-7
Spell Check and Spell Check II messages 8-18
typewriter messages 8-17
typing 8-5
proportional spacing
defined 1-30
erasing in 1-30

Q

Q (Impr) key 1-15

R

recommended batteries 7-12
reducing display glare 1-4
reference 7-1
releasing the left margin 1-21
Reloc (Line Space) key 1-9, 1-14, 1-28
removing batteries 7-14
removing paper 1-14
removing printwheels 7-8

removing ribbon cassettes 7-8
reorder numbers, ribbon cassettes 7-11
repeat keys 1-9
repeating Change 5-13
repeating Find 5-8
repetitive letters, playing back 5-17
repetitive letters, typing 5-16
required carrier return symbol 1-6, 8-15
required hyphen 2-3
Required Page End 5-29
playing back jobs 5-29
symbol 1-6, 8-15
typing 5-29
with Auto Page End 5-29
required space 2-3
resetting top margin 2-22
returning to the last typing position 1-28
revision
adding text 3-16, 3-22
changing from No Print to Character or Delay Print 3-14, 3-27
copying jobs 3-14
deleting text 3-17, 3-22
in Character or Delay Print 3-15
in No Print 3-21
rules 3-27
using Change 5-12
using Find 5-7
using the Directory function 4-4
revision point, playing to 3-15
RFLUSH indicator 1-7, 2-7, 8-16
ribbon
applications 7-10
cassette system 7-8
installing 7-9
latching cassettes together 7-9
matching with correction tape 7-8
removing 7-8
reorder numbers 7-11
take-up wheel color code 7-11
ribbon release lever 7-8
right carrier limit 1-23
right flush 2-7
at any position on a line 2-7

canceling before characters print 2-8
changing printwheels 2-20
revising text in No Print 3-27
symbols 1-6, 2-7, 8-15
typing to the right margin 2-7
right margin
aligning text 2-7
automatic return 2-1
ending lines before 2-2
typing right flush text to 2-7
right margin beep 2-1
RMar (IndR) key 1-21
RMar, pressing with storage open 3-9

S

safety information iv
sample justification printout 5-1
sample preprinted form 5-25
samples, typestyles 7-1
saving format settings 1-24
selecting a menu function 4-2
selecting format areas 1-25
selecting format settings 1-24
separating pages of a multipage job 4-13, 5-29
serial number 7-16
setting bottom margin with Page-Layout 4-10
setting Impression level 1-15
setting margins 1-21
setting page length with Page-Layout 4-10
setting tabs 1-22
setting temporary margins 2-12
setting top margin 2-22
Shift and - (hyphen) 2-16
Shift and Lock keys 1-17
SHIFT indicator 1-7, 1-17, 8-16
skipping blank lines 1-13
South Africa keyboard 6-8
space, required 2-3
Spain keyboard 6-8
special characters 2-11
Spell Check and Spell Check II
changing the spelling beep A-8

- checking all words in a job A-6
- messages 8-18
- overview A-1
- problems 8-7
- Spell Assist A-7
- spelling beep A-8
- supplemental dictionary A-4
 - adding words A-4
 - deleting words A-5
 - viewing and deleting words A-5
- turning on and off A-3
- stop codes 2-20, 3-29
- applications 3-30
- deleting 3-30
- playing back 3-30
- storage 3-29
- storing form letters 5-16
- symbol 1-7, 2-21, 3-29, 8-16
- typing 3-29
- stopping playback 3-6
- storage 3-1
 - assembling documents 5-19
 - changing margins and tabs 3-9
 - closing 3-2
 - contents 4-3
 - defined 3-1
 - identifying current storage area 4-1
 - moving through 3-21
 - opening 3-2, 3-21
 - overview 3-1
 - playing back 3-4
 - pressing F_{rmal} in 3-8
 - pressing L_{Mar} 3-9
 - pressing R_{Mar} 3-9
 - rules 3-25
 - stop codes 3-29
 - typing 3-2
- storage areas, deleting all 3-28
- storage closed, assembling documents 5-20
- storage closed, correcting errors 3-20
- storage full warning 4-8
- storage open, assembling documents 5-20
- STORE Indicator 1-7, 3-1, 4-17, 4-18, 5-7, 5-17, 5-27, 5-28, 8-16

- Store key 3-2
- stored jobs
 - adding text 3-16, 3-20
 - checking all words A-6
 - combining 5-18
 - copying for revision 3-14
 - deleting 3-28
 - deleting text 3-17, 3-20
 - deleting through Directory 4-5
 - displaying list 4-3
 - margin and tab formats 3-8
 - moving tabs 4-15
 - moving tabs in a portion 4-18
 - moving tabs throughout 4-17
 - playing back 3-4
 - playing back through Directory 4-4
 - playing back with Auto Page End on 4-13
 - playing back with required page end 5-29
 - revising 3-14
 - revising in Character or Delay Print 3-15
 - revising in No Print 3-21
 - revising through Directory 4-4
 - revising using Change 5-12
 - revising using Find 5-7
 - typing hyphens 3-11
- storing a form layout 5-28
- storing a job 3-2
- storing a job with Tab Adjust on 4-17
- storing form letters with stop codes 5-16
- storing margin and tab formats 1-24
- subscripts 2-9
 - symbol 1-7, 2-9, 8-16
 - typing 2-9
 - underlining 2-10
- superscripts 2-9
 - symbol 1-7, 2-10, 8-16
 - typing 2-10
 - underlining 2-10
- supplemental dictionary A-4
 - adding words A-4
 - deleting words A-5
 - viewing and deleting words A-5
- supplies, ordering procedures 7-1

- SUSPND Indicator 1-7, 5-19, 8-16
- Sweden keyboard 6-6
- Switzerland (French) keyboard 6-5
- Switzerland (German) keyboard 6-8
- syllable hyphen defined 3-11
- symbols
 - bold 1-6, 2-11, 8-15
 - centering 1-6, 2-5, 8-15
 - decimal tab (begin) 1-6, 8-15
 - decimal tab (end) 1-6, 8-15
 - display 1-6, 8-15
 - indent clear 1-6, 2-13, 8-15
 - indent left 1-6, 2-12, 8-15
 - indent right 1-6, 2-12, 8-15
 - line space 1-6, 1-9, 8-15
 - mark 1-6, 5-28, 8-15
 - pitch 1-19, 7-1
 - pitch change 1-6, 8-15
 - required carrier return 1-6, 8-15
 - required page end 1-6, 8-15
 - right flush 1-6, 2-7, 8-15
 - stop code 1-7, 2-21, 3-29, 8-16
 - subscript 1-7, 2-9, 8-16
 - superscript 1-7, 2-10, 8-16
 - tab 1-7, 8-16

T

- T ADJ Indicator 1-7, 4-16, 8-16
- Tab (InDL) key 1-22
- Tab Adjust 4-9, 4-15
 - playing back jobs 4-17
 - storing jobs 4-17
 - turning off 4-16
 - turning on 4-16
- tab and margin formats in stored jobs 3-8
- tab symbol 1-7, 8-16
- tables and columns 3-25, 3-30, 4-15
- tabs
 - changing after opening storage 3-9
 - clearing 1-22

- clearing all 1-22
- displaying 1-23
- moving during playback 4-17
- moving in a portion of a stored job 4-18
- moving throughout a stored job 4-17
- permanent 1-22
- setting 1-22, 3-9
- TC_{lr} + CR_{tn} 1-22
- temporary margins 2-12
 - canceling 2-13
 - clearing 2-13
 - setting 2-12, 3-9
- text, justification 2-18
- top margin position 1-12
- top margin, changing 2-22
- Turkey keyboard 6-8
- type
 - elite (12 pitch) 1-20
 - micro elite (15 pitch) 1-20
 - pica (10 pitch) 1-20
 - proportional spacing (PS) 1-20
- type size, on printwheel label 1-18
- typematic keys 1-9
- typestyle
 - changing 2-20, 3-31
 - changing in justified text 2-19
 - defined 2-21
- typestyle name, on printwheel label 1-18
- typestyle samples 7-1
- typewriter
 - care and maintenance 7-16
 - cover, cleaning 7-16
 - messages 8-17
 - parts 1-1
 - problems 8-3
 - serial number 7-16
 - turning on and off 1-3
 - using Pinwheel Form Feeder 4-12
- typing line 1-16
- typing problems 8-5

U

U (Cont) key 2-4

underlining

continuous 2-4

numbers in a column 2-16

subscripts 2-10

superscripts 2-10

word 2-4

United Kingdom (PC) keyboard 6-10

United Kingdom keyboard 6-7

United States keyboard 6-4

uppercase characters, typing 1-17

V

variable text, typing in a form 5-24

vertical columns, typing 2-14

vertical inch, lines per 1-19

vertical lines, drawing 1-16

viewing and deleting words from the

supplemental dictionary A-5

viewing formats 3-8

W

warning, storage full 4-8

WHEEL indicator 1-7, 2-21, 3-26, 6-16

word backward 1-14

word erase 1-27

word forward 1-14

Word key 2-4

word underline 2-4

words, hyphenating 5-4

2

² (exponent 2) 2-11

3

³ (exponent 3) 2-11

IBM Wheelwriter® 30 Series II Typewriter 6787

Operator's Guide

Order Number S544-4108-0

Reader's Comment Form

You may use this form to communicate your comments about this publication, with the understanding that IBM may use or distribute whatever information you supply in any way it believes appropriate without incurring any obligation to you.

1. Did you find the book well organized?

Yes No

2. Was the content of the book accurate and complete?

Yes No

3. Was the book easy to use?

Yes No

4. What can we do to improve the book?

5. What is your job title?

Questions or comments about supplies, service, applications, and so on will slow response time considerably. Please refer those questions or comments to your IBM Authorized Dealer or IBM Direct.

Note: Please direct all requests for copies of IBM publications to your IBM Authorized Dealer. Publications are not stocked at the location to which this form is addressed.



NO POSTAGE
NECESSARY
IF MAILED
IN THE
UNITED STATES



BUSINESS REPLY MAIL
FIRST CLASS PERMIT NO. 123 LEXINGTON, KY 40511

POSTAGE WILL BE PAID BY ADDRESSEE

International Business Machines Corporation
Department F98, Building 982-3
740 New Circle Road, N.W.
Lexington, Kentucky 40511

Handwritten signature

Fold Here

Tape

Please Do Not Staple

Tape