



X125 All-In-One

Quick Reference

June 2002

Safety Information

- Connect the power cord to a properly grounded electrical outlet that is near the product and easily accessible.
- Refer service or repairs, other than those described in the operating instructions, to a professional service person.
- Use only Lexmark replacement parts to maintain the safety of this product.
- Do not use the fax function during a lightning storm.

Contents

- Installing the software 1**

- Additional setup instructions 3**
 - Connecting to a telephone 3
 - Connecting to an answering machine 4
 - Connecting to a computer modem 5

- Learning about your All-In-One 7**
 - Understanding the All-In-One 7
 - Using the operator panel 8
 - Loading specialty paper 10
 - Loading a document 11
 - Using the All-In-One software 12
 - Additional software 13

- Faxing 14**
 - Sending a fax 14
 - Receiving a fax 17

- Copying 19**
 - Changing the copy settings 19

- Printing 20**
 - Changing the print settings 20

Scanning	21
Changing the scan settings	22
OCR (Optical Character Recognition)	22
Troubleshooting	23
Checking first things first	23
Setup troubleshooting	23
Solving fax problems	26
Solving copy problems	27
Contacting Lexmark	27
Appendix	28
Federal Communications Commission (FCC) compliance information statement	28
Copyright advisory	28
Ringer Equivalence Number	28
Canadian regulations governing the use of modems	28
Statement of Limited Warranty	29

Installing the software

Your All-In-One is set up to fax and copy without a computer according to the steps listed in your setup documentation. In order to set up your All-In-One to fax, copy, print, and scan with a computer, follow these installation steps:

- 1 Make sure you have completed all of the steps in the setup documentation.
- 2 Make sure your computer is on.
- 3 Click **Cancel** on any screens similar to the one shown.

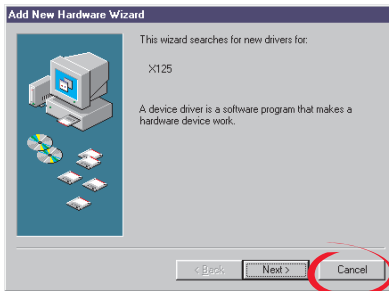

- 4 Insert the CD.

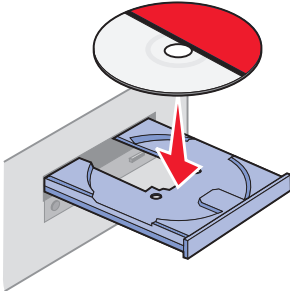

- 5 Wait for the Lexmark All-In-One software installation screen to appear, and then click **Next**.

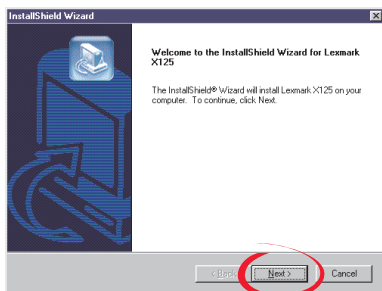

Note: If this screen does not appear, see page 23.

- 6 Continue with the installation steps on your computer screen.

Additional setup instructions

You can connect your All-In-One with a telephone, an answering machine, and a computer modem.

CAUTION: Do not make these connections during an electrical storm.

Connecting to a telephone

Your All-In-One is set up according to the steps listed in your setup documentation. To use the fax line as a normal telephone line, connect a telephone to your All-In-One. There are two different ways to do this. Choose the method that you prefer.

Connecting to the EXT outlet

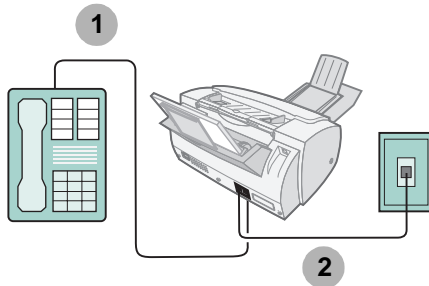

- 1** Connect a phoneline from the telephone to the EXT outlet on the All-In-One.
- 2** Connect a phoneline from the LINE outlet on the All-In-One to the telephone wall jack.

Use the Fax mode or the Tel mode. For help selecting these modes, see page 17.

Connecting to the wall jack

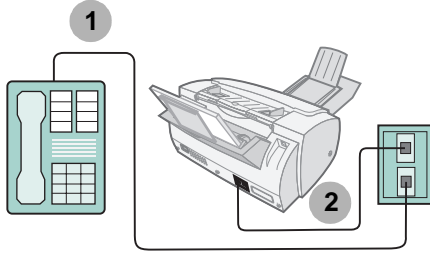

- 1** Connect a phoneline from the telephone to a telephone wall jack.
- 2** Connect a phoneline from the LINE outlet on the All-In-One to a telephone wall jack.

Use the Fax mode or the Tel mode. For help selecting these modes, see page 17.

Connecting to an answering machine

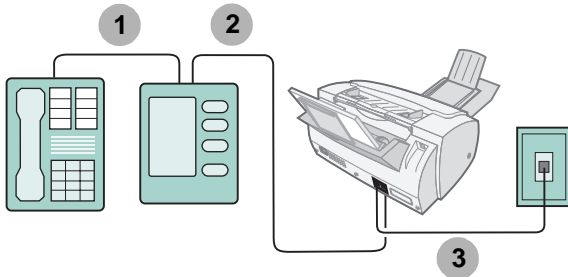

- 1** Connect a phoneline from the telephone to the answering machine.
- 2** Connect a phoneline from the answering machine to the EXT outlet on the All-In-One.
- 3** Connect a phoneline from the LINE outlet on the All-In-One to the telephone wall jack.

Use the Fax mode or the Tel mode. For help selecting these modes, see page 17.

Connecting to a computer modem

Set up without an answering machine

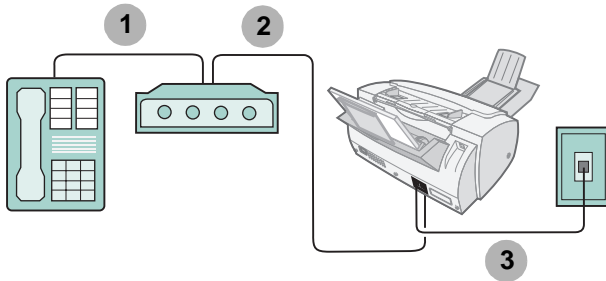

- 1** Connect a phoneline from the telephone to the computer modem.
- 2** Connect a phoneline from the computer modem to the EXT outlet on the All-In-One.
- 3** Connect a phoneline from the LINE outlet on the All-In-One to the telephone wall jack.

Use the Fax mode, the Tel mode, or the Ans/Fax mode. For help selecting these modes, see page 17.

Set up with an answering machine

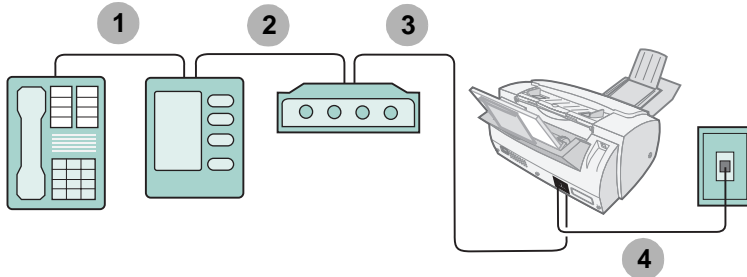

- 1** Connect a phoneline from the telephone to the answering machine.
- 2** Connect a phoneline from the answering machine to the computer modem.
- 3** Connect a phoneline from the computer modem to the EXT outlet on the All-In-One.
- 4** Connect a phoneline from the LINE outlet on the All-In-One to the telephone wall jack.

Use the Tel mode or the Ans/Fax mode. For help selecting these modes, see page 17.

Learning about your All-In-One

Understanding the All-In-One

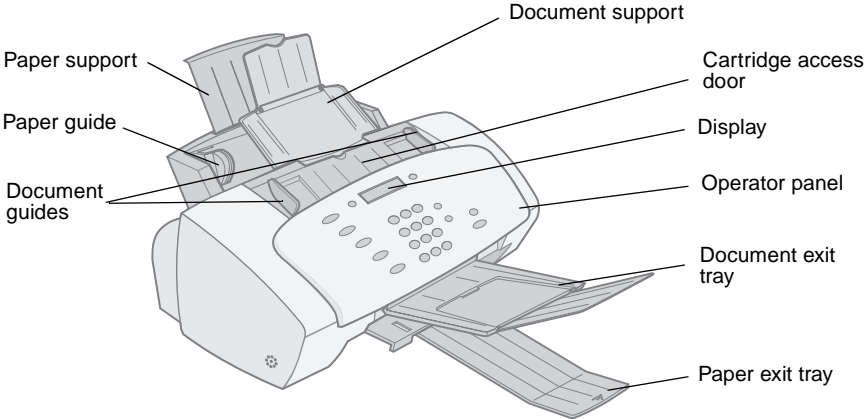

Use this...	When you want to...
Document support	Keep documents straight during copying, scanning, and faxing.
Cartridge access door	Install or replace the cartridges.
Display	Check the status of the All-In-One.
Document exit tray	Stack paper after copying, scanning, or faxing.
Paper exit tray	Stack paper after printing.
Document guides	Make sure documents feed correctly.
Paper guide	Make sure paper feeds correctly.
Paper support	Keep paper straight during printing.

Using the operator panel

The following table describes what each button does. Messages and errors appear on the display when your All-In-One is on.

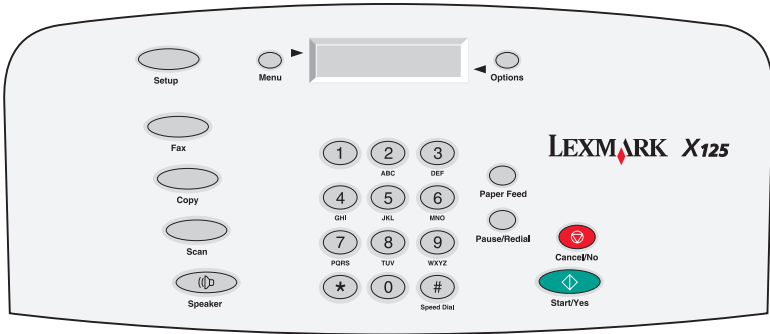

Press...	When you want to...
Menu	Scroll through available features on the display.
Options	Scroll through the settings for the feature you select.
Setup	Access the system setup, maintain your cartridges, and print reports.
Fax	Initiate sending a fax.
Copy	Initiate a copy job.
Scan	Initiate a scan job.
Speaker	Listen as you manually dial and connect to another fax machine.
The keypad buttons	Dial a fax number or select a number of copies.
Speed Dial (# key)	Access the speed dial menu.
Paper Feed	<ul style="list-style-type: none"> Continue printing after reloading the paper support. Remove paper if it does not exit after printing.
Pause/Redial	<ul style="list-style-type: none"> Add a three-second pause when you dial a telephone or fax number to access an outside telephone or fax line. Dial the last number called.

Press...	When you want to...
Cancel/No	Cancel an action or clear an incorrect value, or provide a No response when answering questions.
Start/Yes	Start a copy or scan job, or provide a Yes response when answering questions.

Adjusting the All-In-One settings

Use the **Menu**, **Options**, and **Setup** buttons to navigate the All-In-One menus and to change the settings on your All-In-One.

Settings menus

To display the settings menus press **Fax**, **Copy**, **Scan**, or **Setup**, and then press **Menu**. Use your settings menus to adjust:

- Copy type, contrast, size, and paper type.
- Scan type, contrast, size, and file type.
- Fax type, resolution, and contrast.

Setup menu

To display the Setup menu, press **Setup** and then press **Menu**. Press **Menu** to display each menu feature. To navigate the menu features, press **Options**. Use the Setup menu to:

- Set the date and time
- Print a report
- Maintain your printer
- Set the paper size
- Set the ringer volume
- Set the fax print quality
- Set up fax forwarding
- Set the fax receive mode
- Set up distinctive ringing support
- Select a language to appear on the display.

Loading specialty paper

Follow these guidelines when loading specialty paper:

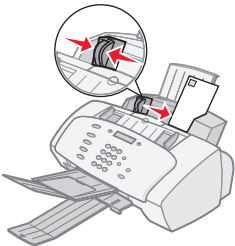
Load up to:	Make sure:
10 envelopes	<ul style="list-style-type: none"> The print side faces you. The envelopes are loaded vertically against the right side of the paper support. The stamp location is in the upper left corner. The paper guide is against the left edge of the envelopes. 
10 greeting cards, index cards, postcards, or photo cards	<ul style="list-style-type: none"> The print side faces you. The cards are loaded vertically against the right side of the paper support. The paper guide is against the left edge of the cards.
25 sheets of coated, photo, or glossy paper	<ul style="list-style-type: none"> The glossy or coated side faces you. The paper guide is against the left edge of the photo paper.
10 transparencies	<ul style="list-style-type: none"> The rough side faces you. The paper guide is against the left edge of the transparencies.
100 sheets of custom size paper	<ul style="list-style-type: none"> The print side faces you. Your paper size fits within these dimensions: <ul style="list-style-type: none"> Width 76 mm to 216 mm 3.0 in. to 8.5 in. Length 127 mm to 432 mm 5.0 in. to 17.0 in. The paper guide is against the left edge of the paper.
25 iron-on transfers	<ul style="list-style-type: none"> You follow the loading instructions on the iron-on packaging. The print (blank) side faces you. The paper guide is against the left edge of the iron-on transfers.

Loading a document

Load documents that you want to fax, copy, or scan in the document support. You can load up to 30 sheets of paper at a time.

You can use your All-In-One to fax, copy, or scan documents that are printed on plain A4, letter, or legal size paper.

Before you load a document into your All-In-One, make sure:

- Your document is at least 76 mm (3.0 in.) long and 140 mm (5.5 in.) wide.
 - You remove all staples and paper clips.
 - You let ink and correction fluid dry completely.
 - You load paper in the paper support.
- 1** Place your document face down and top down in the document support.
 - 2** Slide the document guides toward the paper until they rest against both sides of the paper.

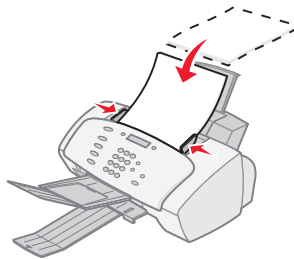

Using the All-In-One software

In addition to changing the settings from the operator panel, you can also change them using the Settings Utility.

To access the Settings Utility, click Start ▶ Programs ▶ Lexmark X125 ▶ Lexmark X125 Settings Utility.

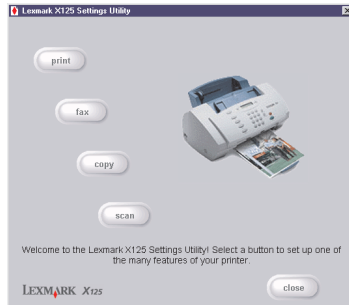

Select...	When you want to...
print	Set up the default printer properties.
fax	Change the fax settings or set up your speed-dial list with frequently dialed numbers.
copy	Change the default copy settings, including copy type, contrast, and size.
scan	Change the default scan settings or scan to: <ul style="list-style-type: none">• A folder on your computer• Your e-mail program• A software application.
close	Close the Settings Utility.

To learn more about how to customize your All-In-One settings, refer to the *Online User's Guide*. To view the guide, click Start ► Programs ► Lexmark X125 *Online User's Guide*.

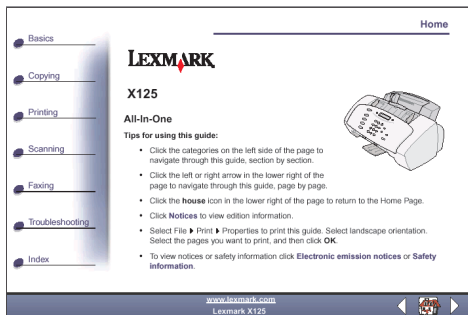

Additional software

To access the scanning and image editing software that came with your All-In-One, click Start ► Programs ► Lexmark X125. Use the software to explore the capabilities of your All-In-One.

Faxing

This section takes you step-by-step through the basics of sending and receiving faxes. It also teaches you the advanced faxing features of your All-In-One, such as speed-dialing, using the speaker, and fax forwarding.

Sending a fax

Use your All-In-One to fax documents that are printed on A4, letter, or legal size paper.

To send a fax with the default settings:

- 1** Load paper in the paper support.
- 2** Load your document. For help, see page 11.
- 3** Press **Fax**.
- 4** Enter the fax number using the operator panel keypad, or press **Pause/Redial** to send the fax to the last number you dialed.
- 5** Press **Start/Yes**.

Changing the fax settings

Use the operator panel or the software to change the fax type, resolution, and contrast.

Using the operator panel	Using the software
<ol style="list-style-type: none">1 Press FAX, and then press Menu repeatedly to review the fax settings.2 Press Options to change the settings.	<ol style="list-style-type: none">1 Make sure you have installed the All-In-One software. For help, see page 1.2 Click Start ▶ Programs ▶ Lexmark X125 ▶ Lexmark X125 Settings Utility.3 Click fax.4 Adjust the settings, and then click OK.

Speed-dialing

You can program up to 70 speed-dial numbers using the Settings Utility. You can store up to 59 individual names and numbers, ten small-group numbers to speed-dial a fax to groups of people on your individual list, and one large-group number to speed-dial a fax to all of the individuals and groups listed. Each speed-dial entry can be a fax number or an e-mail address. To program speed-dial entries for your All-In-One, click Start ▶ Programs ▶ Lexmark X125 ▶ Lexmark X125 Settings Utility ▶ fax ▶ Setup.

To send a fax using a programmed speed-dial entry:

- 1 Press **Speed Dial** (the # button).
- 2 Press **Options** to select the speed-dial destination, or enter a speed-dial number using the operator panel keypad.
- 3 Press **Start/Yes**.

To print a list of all the speed-dial entries available on your system, first press **Setup**, and then press **Menu** repeatedly until you see Print Report. Press **Options** until you see Speed Dial List. Press **Start/Yes** to print the report.

Using the speaker

Use the speaker to dial a fax number, respond to an automated answering system, and then send a fax.

To use the speaker:

- 1** Load the document.
- 2** Press **Speaker**.
- 3** Dial the number using the operator panel keypad.
- 4** Listen to the answering message when your call is answered.

Note: To adjust the volume of the speaker, press **Speaker**, and then press **Menu** repeatedly until Speaker Volume appears. Press **Options** to select the desired volume.

- 5** Press **Start/Yes** when you hear the fax tones.

Note: The speaker is not available when faxes are waiting for automatic redial.

Redial

If a number you dial is busy or there is no answer, your All-In-One automatically disconnects, pauses, and then redials the number. You can use the Settings Utility to set the number of redialing attempts and the interval between attempts. To redial immediately, press **Start/Yes** on the operator panel during the interval between attempts. To stop redialing, press **Cancel/No**.

Press **Pause/Redial** to recall the last number dialed. You can modify the number by pressing **Cancel/No** to clear digits and use the operator panel keypad to add new ones.

Receiving a fax

Your All-In-One has four modes for receiving faxes. The current receive mode appears in the upper right of the display.

Mode:	Function:
Fax	Receive faxes automatically without using your telephone handset. Your All-In-One receives all incoming calls as faxes.
Ans/Fax	Connect your All-In-One and an answering machine to automatically receive both incoming voice messages and faxes.
Tel	Manually receive faxes by pressing either *9* on your telephone keypad or by pressing Start/Yes twice on your All-In-One operator panel.

To change the fax receive mode:

- 1 Press **Setup**, and then press **Menu** until you see Fax Receive Mode on the display.
- 2 Press **Options** until you see the mode you want to select.
- 3 Press **Start/Yes**.

Using Distinctive Ring Pattern Detection (DRPD)

Distinctive ring is a service provided by some telephone companies that assigns two phone numbers to one phoneline, each of which makes your phone ring differently. If you subscribe to this service, you can program your All-In-One to have a distinctive ring pattern and phone number for incoming faxes:

- 1 Press **Setup**, and then press **Menu** until you see Setup DRPD on the display.
- 2 Press **Options** until you see Learn, and then press **Start/Yes**.
- 3 Dial the telephone number that you will use as a fax number.
- 4 Press **Setup**.
- 5 Press **Menu** until you see Fax Receive Mode on the display.

- 6 Press **Options** until you see DRPD, and then press **Start/Yes**.

Your All-In-One detects the ring pattern and answers all incoming faxes on the second ring.

Note: DRPD now appears as a fourth option in the Fax Receive Mode menu.

Fax forwarding

To forward any faxes you receive to another fax machine:

- 1 Press **Setup**.
- 2 Press **Menu** until Fax Forwarding appears on the display.
- 3 Press **Options** until Forward appears.
- 4 If you want to both print a copy of the fax and forward it, press **Options** until Print/Forward appears.
- 5 Press **Start/Yes**.
- 6 Enter the fax number you want your faxes forwarded to.
- 7 Enter the starting month, day, hour, and minute you want Fax Forwarding to begin. If you want to begin immediately, press **Start/Yes**.
- 8 Enter the ending month, day, hour, and minute you want Fax Forwarding to end.

Canceling fax forwarding

- 1 Press **Setup**.
- 2 Press **Menu** until Fax Forwarding appears on the display.
- 3 Press **Options** until Off appears on the bottom line of the display.
- 4 Press **Start/Yes**.

Copying

You can make copies both when your All-In-One is connected to a computer and when it is not connected to a computer.

To copy a document:

- 1 Load paper in the paper support.
- 2 Load your document in the document support. For help, see page 11.
- 3 Press **Copy**.
- 4 Press the keypad buttons to select the number of copies.

Note: You can make up to 100 copies at a time using your All-In-One. The default is one copy.

- 5 Press **Start/Yes**.

Changing the copy settings

Use the operator panel or the software to change the quantity, copy type, contrast, size, and paper type.

Using the operator panel	Using the software
<ol style="list-style-type: none">1 Press Copy, and then press Menu repeatedly to review the copy settings.2 Press Options to change the settings.	<ol style="list-style-type: none">1 Make sure you have installed the All-In-One software. For help, see page 1.2 Click Start ▶ Programs ▶ Lexmark X125 ▶ Lexmark X125 Settings Utility.3 Click copy.4 Adjust the settings, and then click OK.

Printing

Use your All-In-One to print basic or custom jobs.

To print a document:

- 1 Make sure you have installed the All-In-One software. For help, see page 1.
- 2 Load paper in the paper support.
- 3 With your document open, select File ▶ Print.
- 4 To change the All-In-One settings, click Properties or Preferences in the Print dialog box.
- 5 From the Print dialog box, click **OK** or **Print** (depending on the program).

Changing the print settings

Use the Lexmark X125 Settings to customize the print settings. To access the Lexmark X125 Settings from an open document, click File ▶ Print ▶ Properties or Preferences.

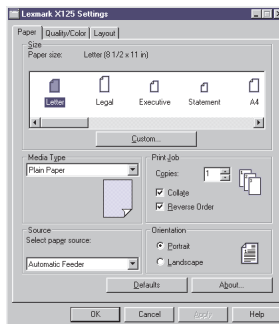

Use the Paper, Quality/Color, and Layout tabs to adjust the print settings.

Scanning

Scan documents when your All-In-One is connected to a computer.

To scan a document:

- 1 Make sure you have installed the All-In-One software. For help, see page 1.
- 2 Load paper in the paper support.
- 3 Load the document in the document support. For help, see page 11.
- 4 Press **Scan**.
- 5 Press **Options** to select the destination of your scan.

Select...	When you want to...
Folder	Scan to a folder on your computer.
E-mail	Scan a document directly into your e-mail program.
Custom applications	Scan a document to a program where you can alter the original. Note: You can define up to six programs as scan-to destinations.

- 6 Press **Start/Yes**.

Note: You can scan a document while your All-In-One is printing, but not while you are faxing or making copies.

Changing the scan settings

You can use the operator panel and the software to change the scan type, contrast, size, and file type:

Using the operator panel	Using the software
<ol style="list-style-type: none">1 Press Scan, and then press Menu repeatedly to review the settings.2 Press Options to change the settings.	<ol style="list-style-type: none">1 Make sure you have installed the All-In-One software. For help, see page 1.2 Click Start ▶ Programs ▶ Lexmark X125 ▶ Lexmark X125 Settings Utility.3 Click scan.4 Adjust the settings, and then click OK.

OCR (Optical Character Recognition)

Your All-In-One includes OCR software that converts a scanned document into a file you can edit with a word processor. Access the OCR software from your computer, or press **Scan** on the operator panel.

Here is an example of how to use OCR:

- 1 From the Settings Utility, select a Scan To application, such as WordPad.
- 2 Select.txt as your file type.
- 3 Load your document into the document support.
- 4 Press **Scan** on the operator panel.

Your document is scanned, converted to text by the OCR software, and loaded into your selected word processing program.

Note: You can use the OCR software to convert typed documents, but not handwritten ones.

Troubleshooting

Checking first things first

If your All-In-One has a problem, first make sure:

- The power cord is plugged into your All-In-One and into a properly grounded electrical outlet.
- Your telephone cord is securely attached to the line jack on your All-In-One and to the wall jack.
- Your telephone has a dial tone.
- The operator panel and the cartridge access door are both completely closed.
- Ready appears on the display.
- The sticker and transparent tape covering the bottom of the cartridges are removed.

Setup troubleshooting

When I inserted the installation software CD, nothing happened.

- 1** Close all open programs.
- 2** Restart your computer.
- 3** Make sure you click **Cancel** on any screens similar to the one in step 3 on page 1.
- 4** Eject, and then reinsert the installation software CD.
- 5** From your desktop, double-click **My Computer**.
- 6** Double-click your **CD-ROM drive** icon. If necessary, double-click **setup.exe**.
- 7** Continue with step 4 on page 1.

The printer or scanner is not working.

1 Check the printer status:

Windows 98/Me/2000	Windows XP
<ol style="list-style-type: none"> 1 Click Start ▶ Settings ▶ Printers. 2 From the Printers folder, double-click the Lexmark X125 printer icon. 3 From the Printer menu, make sure: <ul style="list-style-type: none"> • Default Printer is selected. • Pause Printing is not selected. 	<ol style="list-style-type: none"> 1 Click Start ▶ Control Panel ▶ Printers and Other Hardware ▶ Printers and Faxes. 2 From the Printers folder, double-click the Lexmark X125 printer icon. 3 From the Printer menu, make sure: <ul style="list-style-type: none"> • Default Printer is selected. • Pause Printing is not selected.

2 Check the printer port:

Windows 98/Me	Windows 2000	Windows XP
<ol style="list-style-type: none"> 1 Click Start ▶ Settings ▶ Printers. 2 Right-click the Lexmark X125 printer icon, and then click Properties. 3 Click the Details tab. 4 From the Ports drop-down menu, check the printer port. If the USB port is not listed, uninstall and then reinstall the printer software. For help, see page 25. 5 Click OK. 	<ol style="list-style-type: none"> 1 Click Start ▶ Settings ▶ Printers. 2 Right-click the Lexmark X125 printer icon, and then click Properties. 3 Click the Ports tab. 4 From the list of ports, select the USB printer port. If the USB port is not listed, uninstall and then reinstall the printer software. For help, see page 25. 5 Click Apply. 6 Click OK. 	<ol style="list-style-type: none"> 1 Click Start ▶ Control Panel ▶ Printers and Other Hardware ▶ Printers and Faxes. 2 Click the Ports tab. 3 From the list of ports, select the USB printer port. If the USB port is not listed, uninstall and then reinstall the printer software. For help, see page 25. 4 Click Apply. 5 Click OK.

- 3** Make sure you have not installed multiple copies of the printer software:
 - a** Open the Printers folder for your operating system.

Windows 98/Me/2000: From the Start menu, click Settings ▶ Printers.

Windows XP: From the Start menu, click Control Panel ▶ Printers and Other Hardware ▶ Printers and Faxes.
 - b** In the Printers folder, make sure there is only one **Lexmark X125** printer icon.

If you have installed multiple copies of the printer software, uninstall each copy. Then, restart the computer and reinstall the printer software.

Uninstalling and reinstalling the printer software

If the printer port is incorrect or you have installed multiple copies of the printer software, uninstall and then reinstall the printer software:

- 1** From the Start menu, click Programs or All Programs ▶ Lexmark X125 ▶ Uninstall.
- 2** Follow the instructions on your screen to uninstall the printer software.
- 3** Restart your computer.
- 4** Reinstall the printer software. For help, see page 1.

Solving fax problems

The numbers stored in the Speed-dial memory do not dial correctly.

Make sure the numbers are stored in the speed-dial memory correctly. To print a speed-dial list:

- 1** Press **Setup**.
- 2** Press **Menu** until you see Print Report.
- 3** Press **Options** until you see Speed Dial List.
- 4** Press **Start/Yes** to print the list.

The All-In-One cannot receive faxes automatically.

Make sure your fax receive mode is set to either Ans/Fax or Fax. For help, see page 17.

The All-In-One cannot receive faxes manually.

Make sure you do **one** of the following:

- Press **Start/Yes** twice on the All-In-One operator panel.
- Press ***9*** on your telephone, and then hang up.

Other fax transmission problems

The machine sending you a fax or the machine you are sending a fax to may be turned off, out of paper, or disabled. Contact the owner of that machine if you experience the following problems:

- Your All-In-One will not send a fax.
- Incoming faxes are incomplete.
- Incoming faxes have blank spaces.
- Incoming faxes have spots.
- Incoming faxes are of poor quality.
- Incoming faxes have stretched words.
- Your All-In-One dials a number, but cannot make a connection with another fax machine.

Solving copy problems

PC Not Available appears on the operator panel display

Most of the time, when PC Not Available appears on your operator panel display, you are attempting to make multiple copies while your All-In-One is set to a color copy mode.

If you would like to make multiple black and white copies without a computer, you can change the color mode to Black Draft, Black Normal, or Black Photo using the menus on your operator panel display.

If you would like to make multiple color copies, you must attach your All-In-One to your computer using a USB cable.

- If you have installed the All-In-One software on your computer, click Start ▶ Programs ▶ Lexmark X125 Settings Utility. Use the Lexmark X125 Settings Utility to change the copy settings.
- For All-In-One CD software installation instructions, see page 1.

Contacting Lexmark

Visit our Web site at www.lexmark.com to:

- Register your printer.
- Access publications for your printer.
- Check for upgrades.
- Create and print fun computer projects.

Visit our Web site at <http://support.lexmark.com> to receive technical support.

Appendix

Federal Communications Commission (FCC) compliance information statement

The Lexmark X125 complies with the limits for a Class B digital device, pursuant to Part 15 of the FCC Rules. Operation is subject to the following two conditions:

- (1) this device may not cause harmful interference, and
- (2) this device must accept any interference received, including interference that may cause undesired operation.

Any questions on this statement should be directed to:

Director of Lexmark
Technology & Services
Lexmark International, Inc.
740 West New Circle Road
Lexington, KY 40550
(859) 232-3000

Refer to the online documentation for additional compliance information.

Copyright advisory

It may be illegal to copy certain materials without permission or license, including documents, images, and currency. If you are not sure whether you have permission, seek legal advice.

Ringer Equivalence Number

The Ringer Equivalence Number (REN) assigned to each terminal device provides an indication of the maximum number of terminals allowed to be connected to the telephone interface. The termination on an interface may consist of any combination of devices, subject only to the requirement that the sum of the Ringer Equivalence Numbers of all the devices does not exceed 6.

The Ringer Equivalence Number (6) for this device is 0.6B.

Canadian regulations governing the use of modems

The Industry Canada label identifies certified equipment. This certification means that the equipment meets certain telecommunications network protective, operations, and safety requirements. The Department does not guarantee the equipment will operate to the user's satisfaction.

Before installing the equipment, users should ensure that it is permissible to be connected to the facilities of the local Telecommunications Company. The equipment must also be installed using an acceptable method of connection. In some cases, the companies inside wiring associated with a single line individual service may be extended by means of a certified connector assembly (telephone extension cord). The customer should be aware that compliance with the above conditions might

not prevent degradation of service in some situations.

Repairs to certified equipment should be made by an authorized Canadian maintenance facility designed by the supplier. Any repairs or alterations made by the user to this equipment, or equipment malfunctions, may give the telecommunications company cause to request the user to disconnect the equipment.

Users should ensure for their own protection that the electrical ground connections of the power utility, telephone lines, and internal metallic water pipe system, if present are connected together. This precaution may be particularly important in rural areas.

CAUTION: User should not attempt to make such connections themselves, but should contact the appropriate electric inspection authority or an electrician.

Notice: This equipment meets the applicable Industry Canada Terminal Equipment Technical Specifications. This is confirmed by the registration number. The abbreviation, IC, before the registration number signifies that registration was performed based on a Declaration of Conformity indicating that Industry Canada technical specifications were met. It does not imply that Industry Canada approved the equipment.

Statement of Limited Warranty

Lexmark International, Inc. Lexington, KY

This limited warranty applies to the United States. For customers outside the U.S., refer to the country-specific warranty information that came with your product.

This limited warranty applies to this product only if it was originally purchased for your use, and not for resale, from Lexmark or a Lexmark remarketer, referred to in this statement as "Remarketer."

Limited warranty

Lexmark warrants that this product:

- Is manufactured from new parts, or new and serviceable used parts, which perform like new parts
- Is, during normal use, free from defects in material and workmanship

If this product does not function as warranted during the warranty period, contact a Remarketer or Lexmark for repair or replacement (at Lexmark's option).

If this product is a feature or option, this statement applies only when that feature or option is used with the product for which it was designed. To obtain warranty service, you may be required to present the feature or option with the product.

If you transfer this product to another user, warranty service under the terms of this statement is available to that user for the remainder of the warranty period. You should transfer proof of

original purchase and this statement to that user.

Limited warranty service

The warranty period starts on the date of original purchase as shown on the purchase receipt. The warranty period ends 12 months later.

To obtain warranty service you may be required to present proof of original purchase. You may be required to deliver your product to the Remarketer or Lexmark, or ship it prepaid and suitably packaged to a Lexmark designated location. You are responsible for loss of, or damage to, a product in transit to the Remarketer or the designated location.

When warranty service involves the exchange of a product or part, the item replaced becomes the property of the Remarketer or Lexmark. The replacement may be a new or repaired item. The replacement item assumes the remaining warranty period of the original product.

Replacement is not available to you if the product you present for exchange is defaced, altered, in need of a repair not included in warranty service, damaged beyond repair, or if the product is not free of all legal obligations, restrictions, liens, and encumbrances.

Before you present this product for warranty service, remove all print cartridges, programs, data, and removable storage media

(unless directed otherwise by Lexmark).

For further explanation of your warranty alternatives and the nearest Lexmark authorized servicer in your area, contact Lexmark at (407) 563-4600, or on the World Wide Web at www.lexmark.com.

Remote technical support is provided for this product throughout its warranty period. For products no longer covered by a Lexmark warranty, technical support may not be available or only be available for a fee.

Extent of limited warranty

We do not warrant uninterrupted or error-free operation of any product.

Warranty service does not include repair of failures caused by:

- Modification or attachments
- Accidents or misuse
- Unsuitable physical or operating environment
- Maintenance by anyone other than Lexmark or a Lexmark authorized servicer
- Operation of a product beyond the limit of its duty cycle
- Use of printing media outside of Lexmark specifications
- Supplies (such as ink) not furnished by Lexmark
- Products, components, parts, materials, software, or interfaces not furnished by Lexmark

TO THE EXTENT PERMITTED BY APPLICABLE LAW, NEITHER LEXMARK NOR ITS THIRD PARTY SUPPLIERS OR REMARKETERS MAKE ANY OTHER WARRANTY OR CONDITION OF ANY KIND, WHETHER EXPRESS OR IMPLIED, WITH RESPECT TO THIS PRODUCT, AND SPECIFICALLY DISCLAIM THE IMPLIED WARRANTIES OR CONDITIONS OF MERCHANTABILITY, FITNESS FOR A PARTICULAR PURPOSE, AND SATISFACTORY QUALITY. ANY WARRANTIES THAT MAY NOT BE DISCLAIMED UNDER APPLICABLE LAW ARE LIMITED IN DURATION TO THE WARRANTY PERIOD. NO WARRANTIES, EXPRESS OR IMPLIED, WILL APPLY AFTER THIS PERIOD. ALL INFORMATION, SPECIFICATIONS, PRICES, AND SERVICES ARE SUBJECT TO CHANGE AT ANY TIME WITHOUT NOTICE.

Limitation of liability

Your sole remedy under this limited warranty is set forth in this document. For any claim concerning performance or nonperformance of Lexmark or a Remarketer for this product under this limited warranty, you may recover actual damages up to the limit set forth in the following paragraph.

Lexmark's liability for actual damages from any cause whatsoever will be limited to the amount you paid for the product that caused the damages. This limitation of liability will not apply to claims by you for bodily injury or damage to real property or tangible personal

property for which Lexmark is legally liable. IN NO EVENT WILL LEXMARK BE LIABLE FOR ANY LOST PROFITS, LOST SAVINGS, INCIDENTAL DAMAGE, OR OTHER ECONOMIC OR CONSEQUENTIAL DAMAGES. This is true even if you advise Lexmark or a Remarketer of the possibility of such damages. Lexmark is not liable for any claim by you based on a third party claim.

This limitation of remedies also applies to claims against any Suppliers and Remarketers of Lexmark. Lexmark's and its Suppliers' and Remarketers' limitations of remedies are not cumulative. Such Suppliers and Remarketers are intended beneficiaries of this limitation.

Additional rights

Some states do not allow limitations on how long an implied warranty lasts, or do not allow the exclusion or limitation of incidental or consequential damages, so the limitations or exclusions contained above may not apply to you.

This limited warranty gives you specific legal rights. You may also have other rights that vary from state to state.



Lexmark and Lexmark with diamond design are trademarks of Lexmark International, Inc., registered in the United States and/or other countries.

© 2002 Lexmark International, Inc.

740 West New Circle Road

Lexington, Kentucky 40550